

# Declaration

1. This manual is designed for the usage of X-100 PAD, applying to X-100 PAD automotive diagnosis platform.

No part of this manual can be reproduced, stored in a retrieval system or transmitted, in any form or by any means (electronic, mechanical, photocopying, recording, or otherwise), without the prior written permission of Xtool.

2. Use the device only as described in this manual. The user will be responsible solely for the after-effects of violating the laws and regulations caused by using the product or its data information, in this case Xtool will not bear any legal responsibility.

3. Xtool shall not be liable for any incidental or consequential damages or for any economic consequential damages arising from the accidents of individual users and the third parties, misuse or abuse of the device, unauthorized change or repair of the device, or the failure made by the user not to use the product according to the manual.

4. All information, specifications and illustrations in this manual are based on the latest configurations and functions available at the time of printing. Xtool reserves the right to make changes at any time without notice.

5. **XTOOL** is the registered trademark of SHENZHEN XTOOLTECH CO.,LTD.

6. In countries that the trademarks, service marks, domain names, logos and the name of the company are not registered, Xtool claims that it still reserves the ownership of the unregistered trademarks, service marks, domain names, logos and the company name. All other marks for the other products and the company's name mentioned in the manual still belong to the original registered company.

You may not use the trademarks, service marks, domain names, logos and company name of Xtool or other companies mentioned without

written permission from the trademark holder.

7. Please visit [www.xtooltech.com](http://www.xtooltech.com) for more information on the X-100 PAD.

8. Xtool reserves the right for the final interpretation of this manual content.

### **Xtool X-100 PAD User Manual Instructions**

Please read this user manual carefully before using the X-100 PAD.

When reading the manual, please pay special attention to the words “Note”, “Caution” or “Warning”, read them carefully for appropriate operation.

### **Xtool X-100 PAD Main Unit**

Avoid shaking or dismantling the unit as it may damage the internal components.

Do not use hard or sharp objects to touch the LCD screen; do not use excessive force; do not expose the screen to strong sunlight for a long period.

Caution: keep it away from water, moisture, high temperature or very low temperature.

If necessary, calibrate the screen before testing to ensure the accuracy of LCD performance.

Keep the main unit away from strong magnetic fields.

### **Operation Instructions**

For safe operation please follow the instructions below:

Keep the scanner away from heat or fumes when using it.

If the vehicle battery contains acid, please keep your hands and skin or fire sources away from the battery during testing.

Exhaust gas of vehicle contains harmful chemicals, please ensure adequate ventilation.

Do not touch the cooling system components or exhaust manifolds when engine is running due to the high temperatures reached.

Make sure the car is securely parked, Neutral is selected or the

selector is at P or N position to prevent the vehicle from moving when engine starts.

Make sure the (DLC) diagnostic link connector is functioning properly before starting the test to avoid damage to the Diagnostic Computer.

Do not switch off the power or unplug the connectors during testing, otherwise you may damage the ECU and/or the Diagnostic Computer.

## Content

<b>CHAPTER I About X-100 PAD</b> .....	3
1. Features .....	3
2. Layout of X-100 PAD .....	4
3. Hardware Technical Parameters .....	5
<b>CHAPTER II How to Use X-100 PAD</b> .....	6
1. X-100 PAD Activation .....	6
2. X-100 PAD Main Interface and Functional Buttons Descriptions.....	7
2.1. Main Interface .....	7
2.2. Sub-menu and Functional Buttons.....	7
2.3. Toolbar Functional Buttons .....	8
3. Special Functions .....	8
4. Settings .....	8
5. Diagnostic Report .....	13
6. One Click Update .....	14
7. Xtool Cloud System.....	15
8. Remote Diagnosis .....	15

# CHAPTER I About X-100 PAD

## 1. Features

### 1.1. Advancements

- Multi-language. Can be used in different countries and districts.
- Mainframe system, adopts ARM high-speed chip, has a speedy response, strong capacity of anti-interference and stable operation
- Supports one-click update. You can update the software at anytime via WIFI.
- Modern appearance design and HD LCD Panel. It realizes the integration of automobile industry and electronic information technology, and makes vehicle diagnosis more convenient, more practical and more economical.

### 1.2. Durability

- One piece structure design: crash-proof, seismic-proof, durable.
- Industrialized design: ensure stable working condition of the product under the harsh working environment(high or low temperature environment).

## 2. Layout of X-100 PAD

### 2.1. X-100 PAD

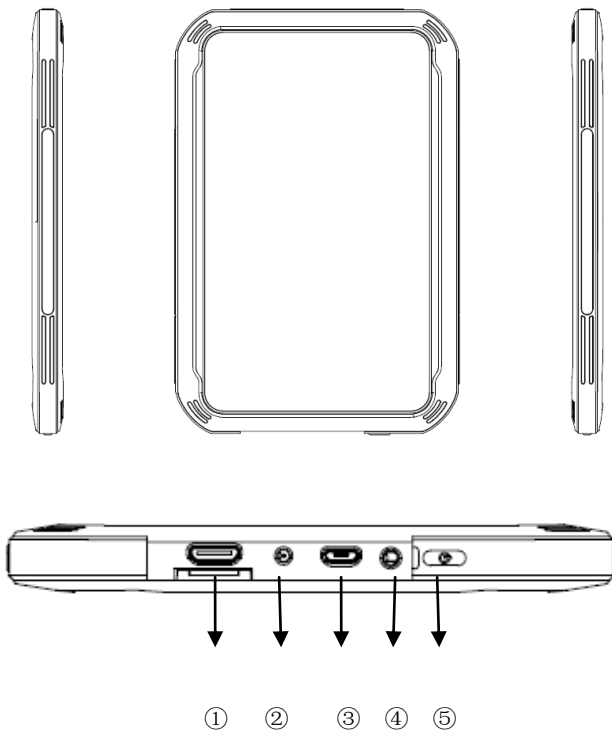

- ① Micro USB: Battery charge or data synchronization with PC.
- ② DC Port: Battery charge.
- ③ HDMI Port: Compatible with HDMI TV: simultaneously transmit both audio and video.
- ④ Audio Port: plug in earphones
- ⑤ Power Button

### 3. Hardware Technical Parameters

Operating System: Android

Processor: Quad-core 1.30GHz Processor

Memory: 1G RAM, 8G FLASH

Display: 7 inch IPS 5-point multi-touch screen with 1024×600P resolution

Sensors: Gravity Sensor, Light Sensor

Auto Input/Output: Microphone, Dual Speakers, 4-Band 3.5 mm stereo/standard headset jack

Power and Battery: 2400mAh, 3.7V lithium-polymer battery

Power Voltage: 5V

Power Consumption: 8W

Operating Temperature: -20 to 50°C (-4 to 126°F)

Humidity: <90%

Dimension (L\*W\*H): 208\*140\*15.5mm

## CHAPTER II How to Use the X-100 PAD

### 1. X-100 PAD Activation

1.1. Please activate X-100 PAD before you use it to test vehicles.



1.2. Input activation code, product serial number (each device will have a serial number and activation code), nickname (workshop's name or user's nickname), login account (can be your email address or cell phone number) and password, the system will then save it. Activation is a one time process. The diagnostic application will start after activation.



## 2. X-100 PAD Main Interface and Functional Buttons Descriptions

### 2.1. Main Interface

Tap on X-100 PAD application icon, the main interface and sub-menus will be shown as below. ▼

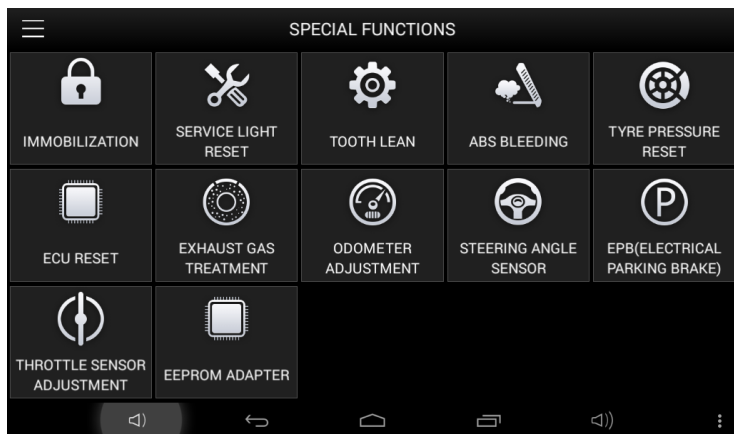

### 2.2. Sub-menus and Function Buttons

**Diagnosis:** Open the X-100 PAD diagnostic application. It can read diagnostic information, view live data, perform actuation tests and special functions etc.





**Diagnosis Report:** Users can view all the diagnostic reports and diagnostic data generated in the diagnosis process.

**Setting:** Users can access the language setting and other system related settings.

**Xtool Cloud:** Online Communication Platform for X-100 PAD users.

**Update:** after connected to the internet, you can download the latest diagnostic software directly to the X-100 PAD.

**Remote Diagnosis:** Users get remote assistance from Xtool Technical Assistance Center.

Function Button	Descriptions
	Back to previous interface
	Back to the main interface of Android System
	Shows (recently used) applications
	Long press for screen captures, short press for turning on the camera

### 2.3. Toolbar Function Buttons

## 3. Special Functions

After the VCI box is connected to the vehicle and paired with X-100 PAD mainframe via wired or wireless connection, diagnosis can be performed. The diagnostic interface is as shown below:

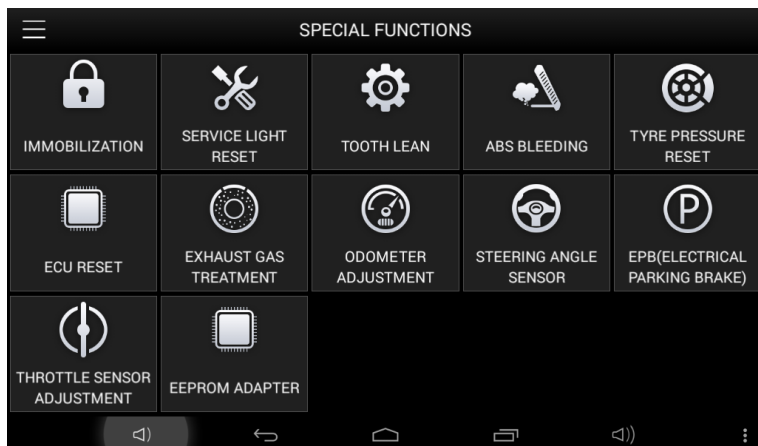

## 4. Settings

By selecting **Setting** users can set the language, unit and other system related options:

4.1. Languages: select the language. Please tick the required option from the multi-language options on the right.



### 4.2. Bluetooth:

Enter homepage to find and pair the VCI serial number with the mainframe. If it needs input the pairing password, you can input the last five numbers of the serial number. (e.g: 00005).



Select the VCI serial number and X-100 PAD will pair with it automatically when running X-100 PAD APP.

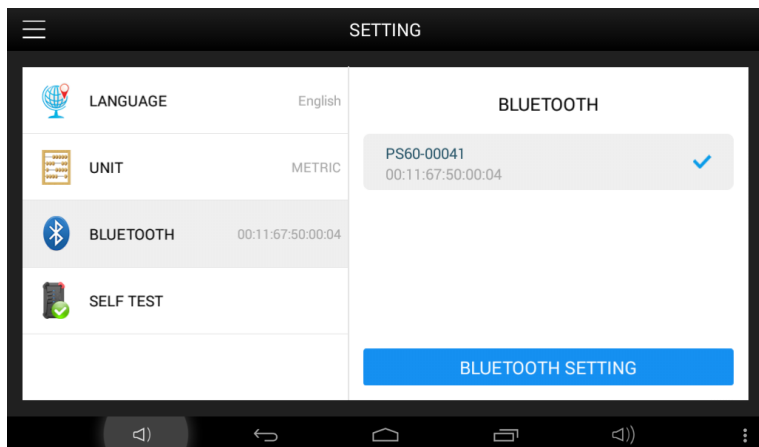

4.3. Units: Select unit of measurement. Users can select Metric or British Unit.

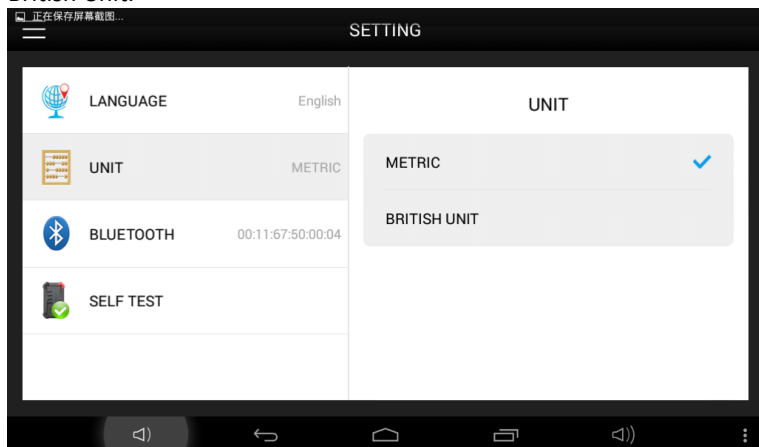

4.4. Device Self Test

Self-test the VCI interface. Please send X-100 PAD back to our factory for repair if self test fails.

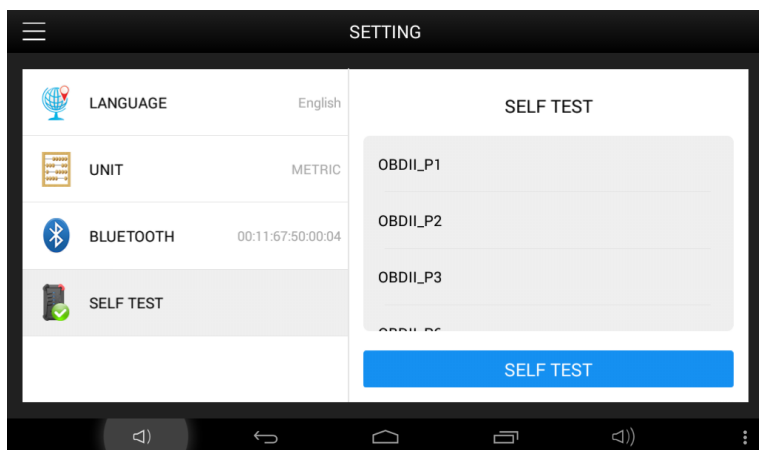

## 5. Diagnostic Report

Provides vehicle maintenance documents including Automotive Technical Manuals, Maintenance Cases, Circuit Diagram, Common Trouble Codes, etc.

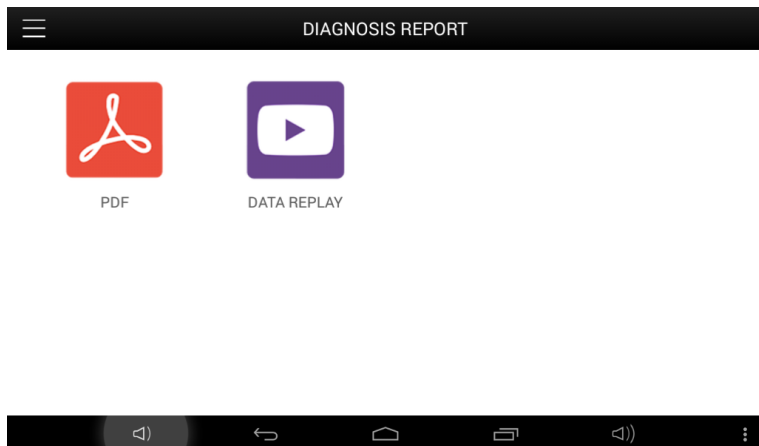

## 6. One Click Update

X-100 PAD updates directly via the Internet using WiFi or wired connection. To access the update application open the X-100 PAD application and click UPDATE , shown below:



## 8. Remote Diagnosis

If users encounter problems and are not able to solve them, they can open this application and ask for remote assistance.

How to get remote assistance from Xtool Technical Assistance Center:

- Open X-100 PAD
- Click **Remote Diagnosis** and open the **TeamViewer** interface. Generate and display device ID.
- Your partner will also need to download and install **TeamViewer**.
- Inform your partner of your **TeamViewer** ID and password to enable them to begin remote access of X-100 PAD.

