



D8 Smart Diagnosis System User Manual



Shenzhen Xtooltech Intelligent Co., LTD

Please read this user manual carefully before using the D8 Smart Diagnosis System. When reading the manual, please pay attention to the words “Note” or “Caution”, and read them carefully for appropriate operation.

TRADEMARKS

XTOOL is a registered trademark of Shenzhen Xtooltech Intelligent CO., LTD.

In countries that the trademarks, service marks, domain names, logos and the name of the company are not registered, Xtool claims that it still reserves the ownership of the unregistered trademarks, service marks, domain names, logos and the company name. All other marks for the other products and the company’s name mentioned in the manual still belong to the original registered company.

You may not use the trademarks, service marks, domain names, logo and company name of Xtool or other companies mentioned without written permission from the trademark holder.

Xtool reserves the right for the final interpretation of this manual content.

COPYRIGHT

Without the written consent of Shenzhen Xtooltech Intelligent Co., Ltd., any company or individual shall not copy or backup this operation manual in any form (electronic, mechanical, photocopying, recording or other forms).

DECLARATION

This manual is designed for the usage of D8 Smart Diagnosis System, and provides operating instructions and product descriptions for users of the D8 Smart Diagnostic system.

No part of this manual can be reproduced, stored in a retrieval system or transmitted, in any form or by any means (electronic, mechanical, photocopying, recording, or otherwise), without the prior written permission of Xtool.

Use the device only as described in this manual. Xtool is not responsible for any consequences of violating the laws and regulations caused by using the product or its data information

Xtool shall not be liable for any incidental or consequential damages or for any economic consequential damages arising from the accidents of individual users and the third parties, misuse or abuse of the device, unauthorized change or repair of the device,

or the failure made by the user not to use the product according to the manual.

All information, specifications and illustrations in this manual are based on the latest configurations and functions available at the time of printing. Xtool reserves the right to make changes at any time without notice.

OPERATION INSTRUCTIONS

For safe operation, please follow the instructions below:

- Keep the device away from heat or fumes when you using it.
- If the vehicle battery contains acid, please keep your hands and skin or fire sources away from the battery during testing.
- Exhaust gas of vehicle contains harmful chemicals, please ensure adequate ventilation.
- Do not touch the cooling system components or exhaust manifolds when engine is running due to the high temperatures reached.
- Make sure the car is securely parked, Neutral is selected or the selector is at P or N position to prevent the vehicle from moving when engine starts.
- Make sure the (DLC) diagnostic link connector is functioning properly before starting the test to avoid damage to the Diagnostic Tablet. Tablet

- Do not switch off the power or unplug the connectors during testing, otherwise you may damage the ECU and/or the Diagnostic Tablet.

CAUTIONS!

- Avoid shaking or dismantling the unit as it may damage the internal components.
- Do not use hard or sharp objects to touch the LCD screen;
- Do not use excessive force;
- Do not expose the screen to strong sunlight for a long period.
- Please keep it away from water, moisture, high temperature or very low temperature.
- If necessary, calibrate the screen before testing to ensure the accuracy of LCD performance.
- Keep the main unit away from strong magnetic fields.

AFTERSALES-SERVICES

✉ E-Mail: aftersales-services@Xtooltech.com

☎ Tel: +86 755 21670995 or +86 755 86267858 (China)

🌐 Official Website: www.Xtooltech.com

CONTENT

TRADEMARKS.....	I
COPYRIGHT.....	II
DECLARATION.....	II
OPERATION INSTRUCTIONS.....	III
CAUTIONS!.....	IV
AFTERSALES-SERVICES.....	IV
1 GENERAL INTRODUCTION.....	4
Tablet.....	4
<i>Front View of Tablet.....</i>	<i>5</i>
<i>Back View of Tablet.....</i>	<i>6</i>
<i>Host Ports.....</i>	<i>7</i>
Technical Specifications.....	8
Packing List.....	9
2 GETTING STARTED.....	10
Guide to Activation.....	10
Main Interface.....	15
<i>Operation system.....</i>	<i>15</i>
<i>Diagnosis system entrance.....</i>	<i>18</i>
<i>Function Buttons.....</i>	<i>19</i>
<i>Navigation Buttons.....</i>	<i>20</i>
<i>Notification Bar.....</i>	<i>20</i>
3 UPDATE.....	22

4	DIAGNOSIS.....	23
	Vehicle Connection.....	23
	Diagnosis.....	24
	<i>Vehicle Selection.....</i>	<i>25</i>
	<i>Basic functions.....</i>	<i>30</i>
5	SPECIAL FUNCTIONS.....	37
	Key Programming.....	38
	EEPROM Adapter.....	39
	EPB Reset.....	40
	OIL Light Reset.....	41
	SAS Reset.....	41
	TPS Match.....	42
	Injector Coding.....	42
	ABS Bleeding.....	43
	Gearbox Match.....	44
	Gear Learning.....	44
	SRS Reset.....	45
	DPF Regeneration.....	45
	BMS Match.....	46
	Air Suspension.....	47
	Cylinder.....	48
	TPMS Reset.....	48
	Tyre Refit.....	49
	Head Adjustment.....	49
	Windows Initialization.....	49

Seat Match.....	50
Electronic Pump Activation.....	50
Transport Mode.....	50
DIY Mode.....	50
ODO Reset.....	51
6 SETTINGS.....	52
Language.....	53
Units.....	53
My Workshop Info.....	54
VCI Information.....	55
About.....	56
7 REPORT.....	58
Report.....	59
8 REMOTE ASSISTANCE.....	61
SHENZHEN XTOOLTECH INTELLIGENT CO., LTD.....	63

1 GENERAL INTRODUCTION

The Xtool D8 smart diagnostic system is an advanced flatbed (建议删除) scanning tool based on the Android operating system. It supports multi-language switching and is suitable for different countries and regions. The advantage of this OBD II scanner is not only its comprehensive functions, including complete system diagnosis, all OBD II functions, various reset functions (IMMO / EEPROM adapter / EPB (Electronic Parking Brake) reset / oil light reset / SAS (Steering Angle Sensors) reset / TPS (Throttle Position Sensor) matching / Injector coding / ABS (Anti-block system) bleed / gearbox matching / gear learning / electronic pump actuation / disable transport mode / SRS (Supplemental Restrgint System) reset / exhaust post-processing / BMS matching / air suspension / cylinder / TPMS reset / tire refit / headlight adjustment / windows Initialization/seat matching/DIY mode) can also achieve faster and more accurate diagnosis.

TABLET

The main unit of the D8 is the tablet, which has a built-in VCI module, which can be directly connected to the tablet and the car

with the main test cable, without the need to connect to an external VCI box via Bluetooth.

FRONT VIEW OF TABLET



Fig 1-1 Tablet Front View

The front of the main unit is a touchable display screen, you can use your fingers to operate on the screen to complete the car diagnosis.

BACK VIEW OF TABLET

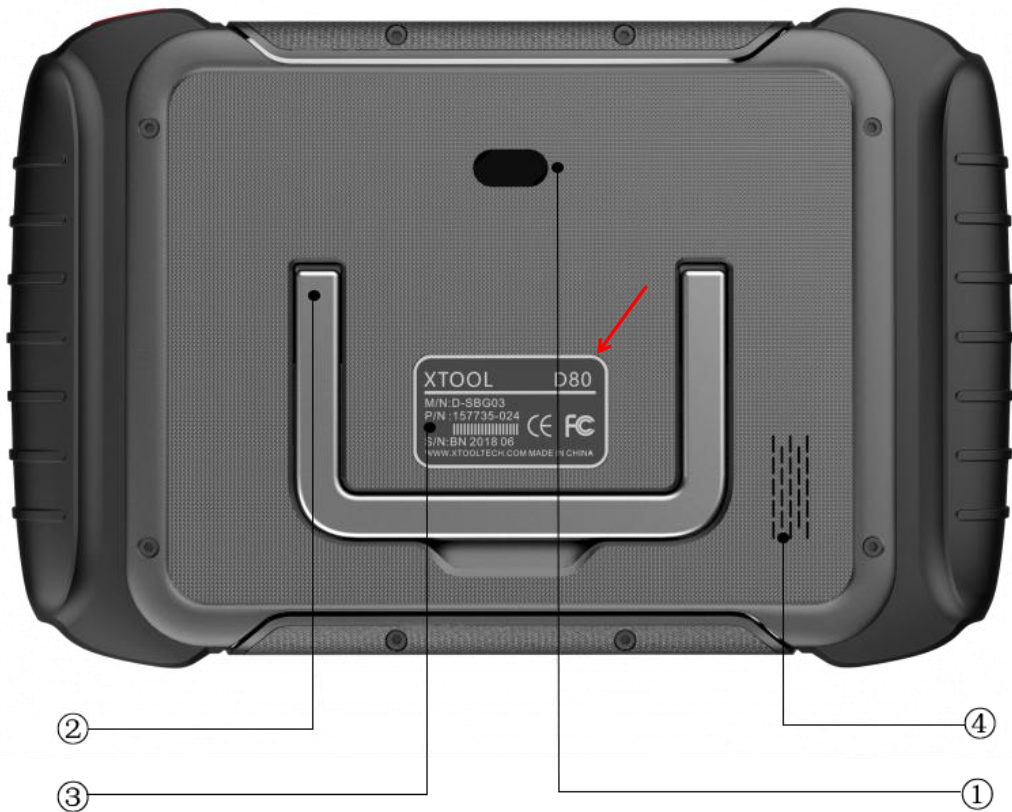

Fig 1-2 Tablet Back View

- ① **Camera:** 8-megapixel camera, for taking pictures.
- ② **Tablet Holder:** Used to support the tablet, flexible adjustment of the tablet height as needed.
- ③ **Nameplate:** Display the basic information about tablet such as product name and model etc.
- ④ **Loudspeaker:** It supports external sound playback..

HOST PORTS



Fig 1-3 Tablet Host Ports

- ① **USB 3.0 port:** Data transfer interface for tablet communication and diagnostics.
- ② **VGA port:** Diagnostic communication interface, which can be used for diagnosis.
- ③ **DC charging port:** Charging port, connected to the charger can be charged.
- ④ **Power button:** Long press to turn on/off, short press to rest/brighten the screen.

TECHNICAL SPECIFICATIONS

Table 1-1 Specifications

Item	Description
OS	Android
Processor	Quad-core processor 1.8GHz
RAM	2G
ROM	64G
Display	8-inch capacitive, 1024×768 resolution
Connectivity	USB Wi-Fi
Camera	8-megapixel autofocus rear camera with flash
Sensor	Gravity sensor
Audio input/ Audio output	Microphone/ Loudspeaker
Ports	<ul style="list-style-type: none"> ● USB3.0 ● DC charging port ● VGA port
Battery	10000mAh 3.7V lithium polymer battery
Input voltage	12V DC
Operating temperature	-10~50°C
Relative humidity	< 90%
Dimensions	274.0×175.0×33.8 mm

PACKING LIST

Table 1-2 Packing List

Category	No.	Name	QTY
Test	1	OBD II-16	1
Connectors and Cables	2	DB15 to VGA Cable	1
	3	USB 3.0 Cable	1
Adaptor	1	DC12V(AC100~240V) 3A	1
	2	US power cable	1
	3	EU power cable	1
Main Unit	1	P804	1
Accessories	1	Tool kit	1
	2	Certificate of Quality	1
	3	Packing List	1
	4	User Manual	1
	5	Carton	1

*Note

To better protect the battery, it is recommended that the diagnosis device be charged at an ambient temperature of 0~40°C!

2 GETTING STARTED

GUIDE TO ACTIVATION

After first time users turn on the system, the system will automatically enter the guide process and request the user to select the system operating language.

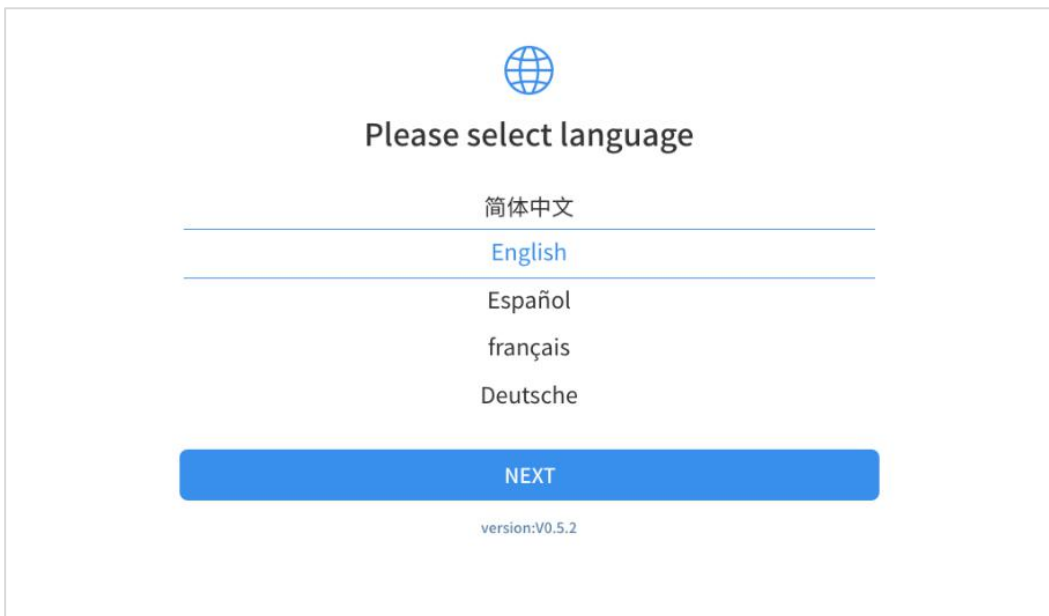

Fig 2-1

After selecting the system language, click **Next** to enter the Wi-Fi connection page, as shown below:

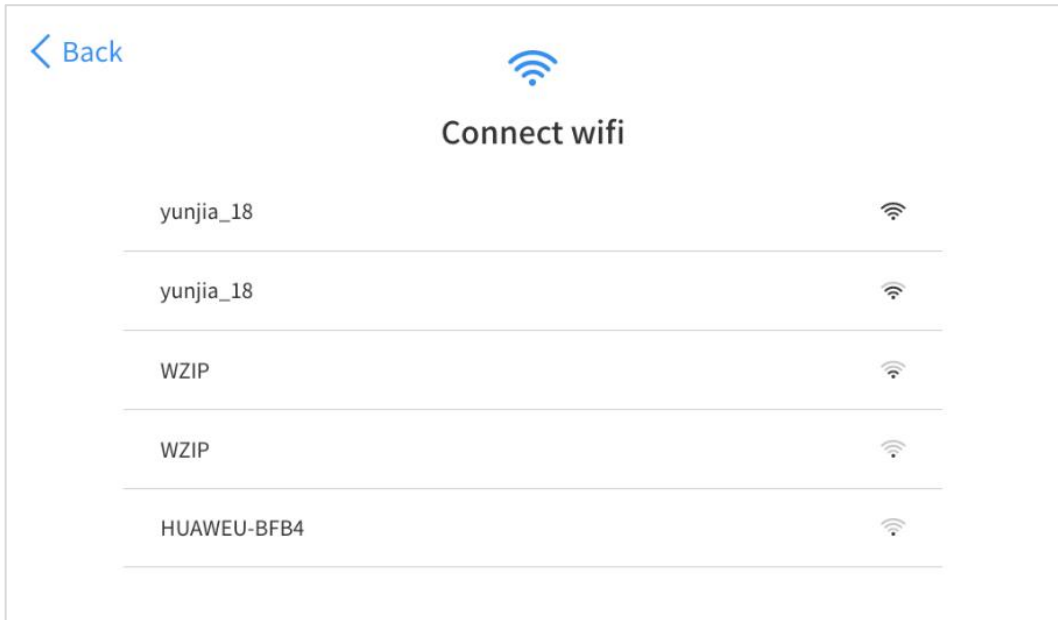

Fig 2-2

Select a network to connect to on the Wi-Fi connection page. After successful network connection, the automatic system will jump to **Factory mode** to download the software:

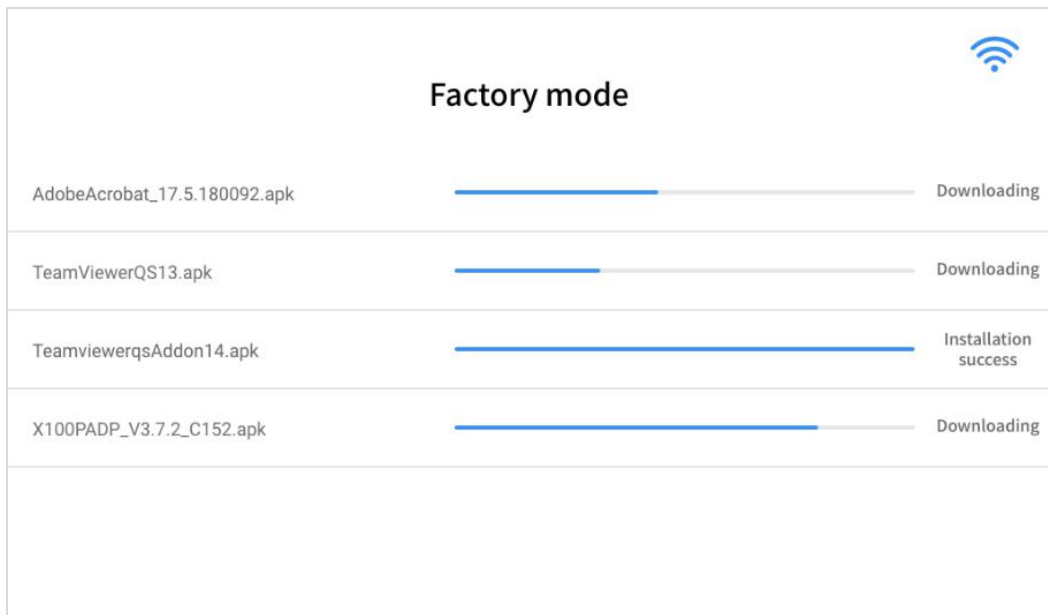

Fig 2-3

Once the software has been downloaded, the tablet will automatically reboot and request the system language selection again.

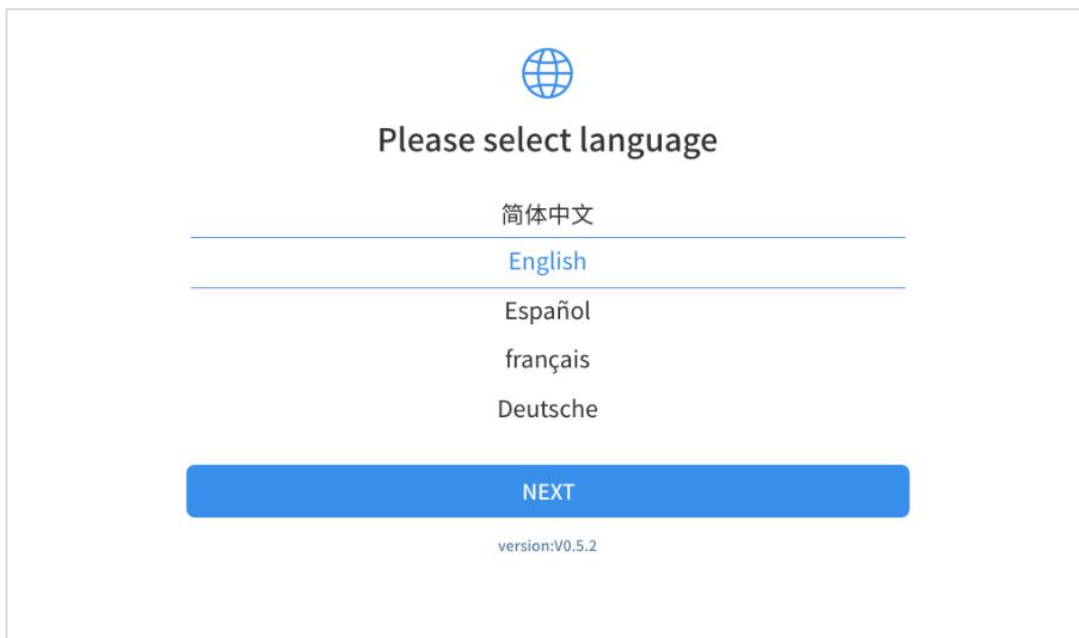

Fig 2-4

After setting the system language, you will enter the activation page, as shown in the figure below. You can also click the "Trial" button in the upper right corner to try it out before activation.

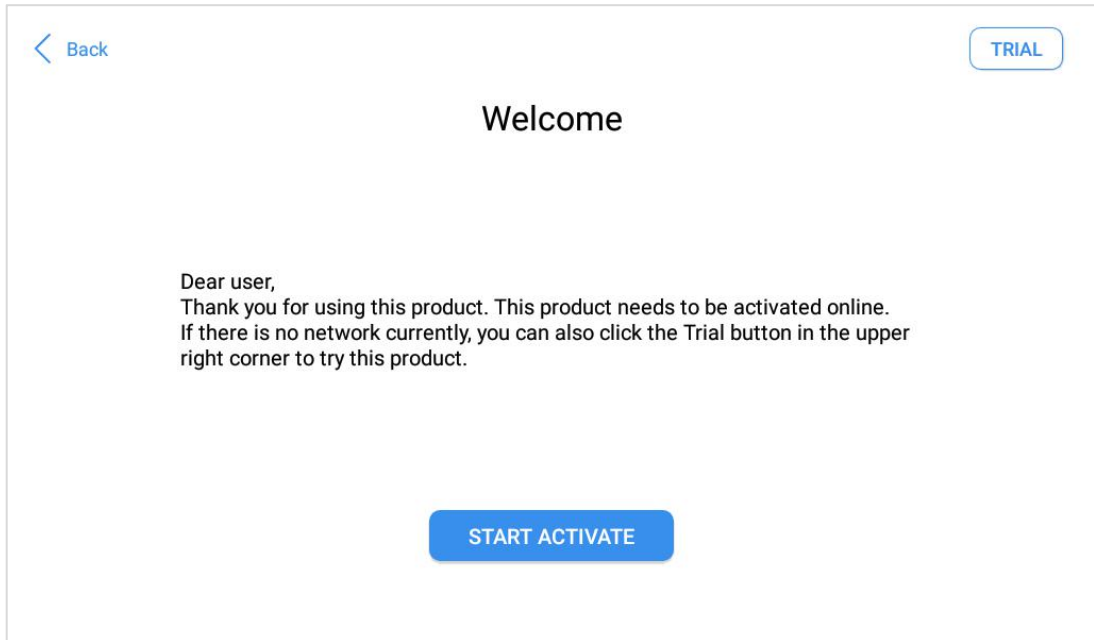

Fig 2-5

Click **Start Activate** to enter the activation page, as shown below:

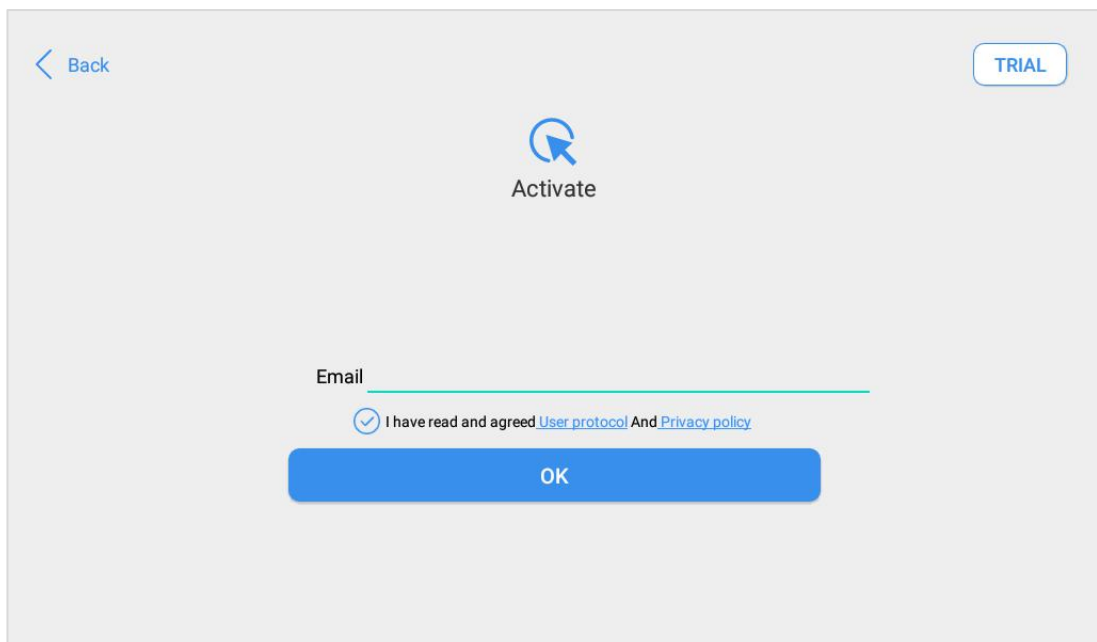

Fig 2-6

A pop-up window showing **Activation Success** indicates that you have completed the first boot setup, click **OK** to enter the diagnostic system and start using the device.

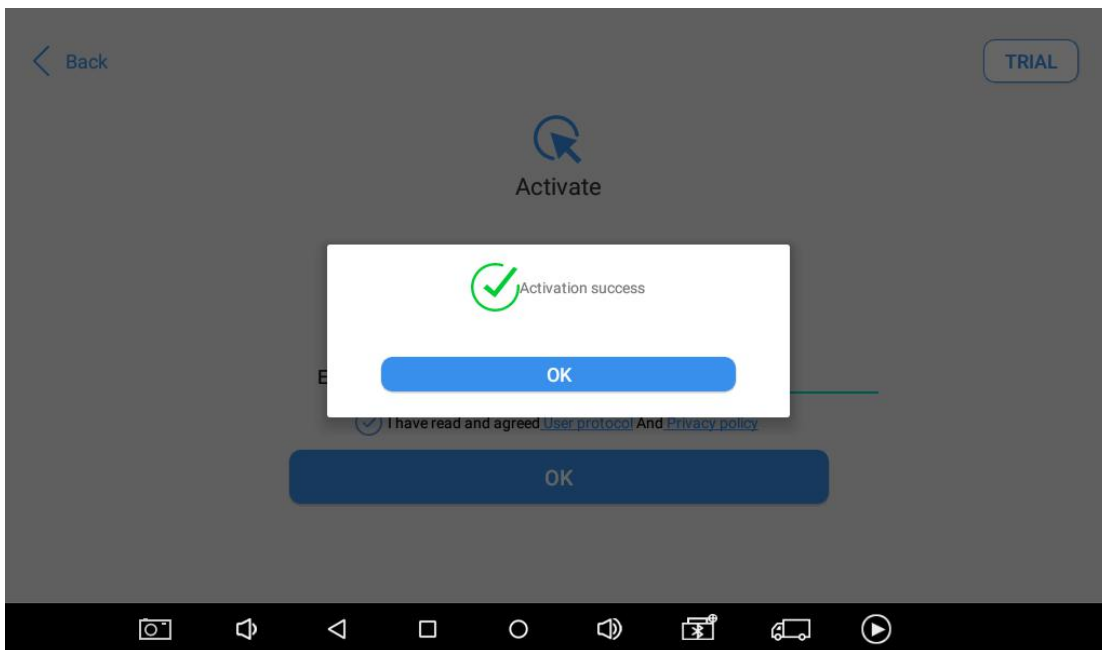

Fig 2-7

MAIN INTERFACE

OPERATION SYSTEM

As shown in the figure below, this interface is the main page of the operating system of the device. You can also return to this interface at any time by clicking **【】** on the bottom navigation bar.

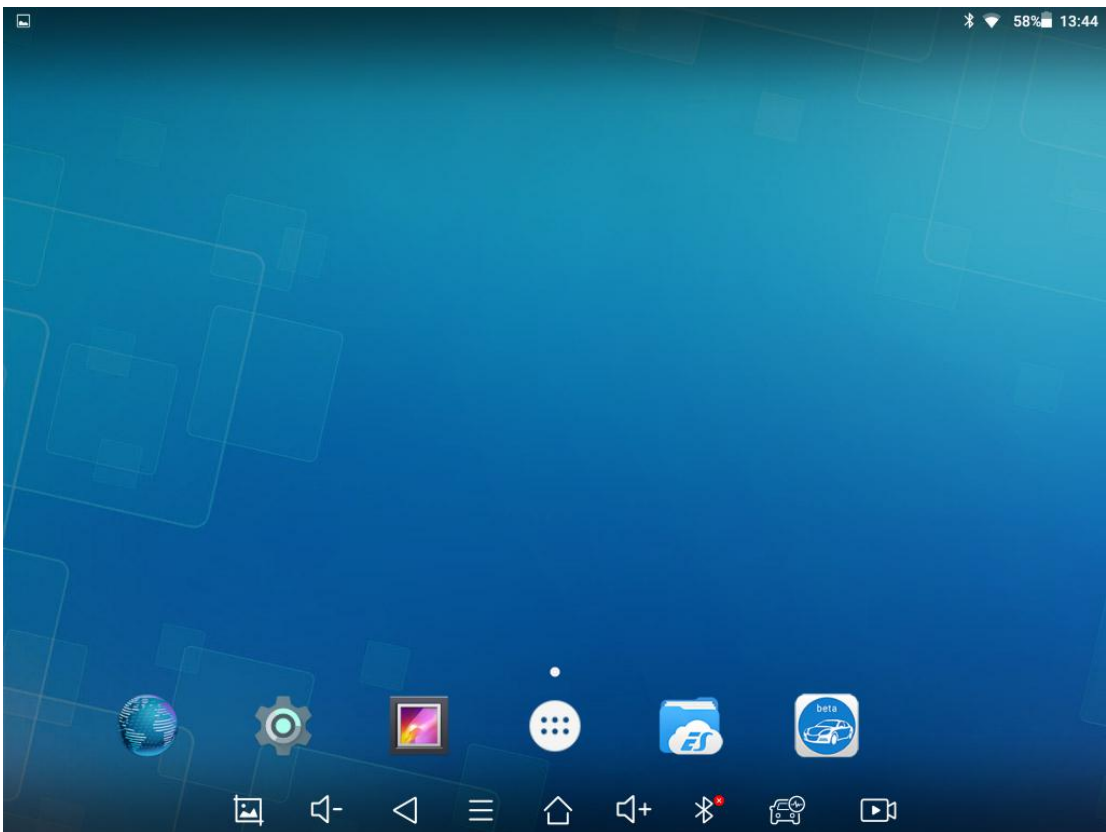

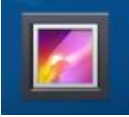





Fig 2-8

The icons on the right, from top to bottom, are browser, photo album, application square, file manager, system settings, as shown below:

Table 2-1

Items	Descriptions
	Browser
	Album
	Application Square
	File Explorer
	Settings for Android System
	D8 Smart Diagnosis System

- a) **Browser:** Click on the browser icon to enter the browser to view the official website of Xtool or search for other information.
- b) **Gallery:** Click the **Gallery** icon to enter the album to quickly view the pictures or screenshots stored in the device. You can select the picture you need, click the share button on the upper

right, and send the picture to your mobile phone or PC via Bluetooth or USB connection

- c) **Application Square:** \You can remove or add Apps here. (此处描述错误)
- d) **ES File Explorer:** You can manage APP, music, files, pictures, etc. in the device in this function, and you can also use Local/Home/Cleaner to clean up files.

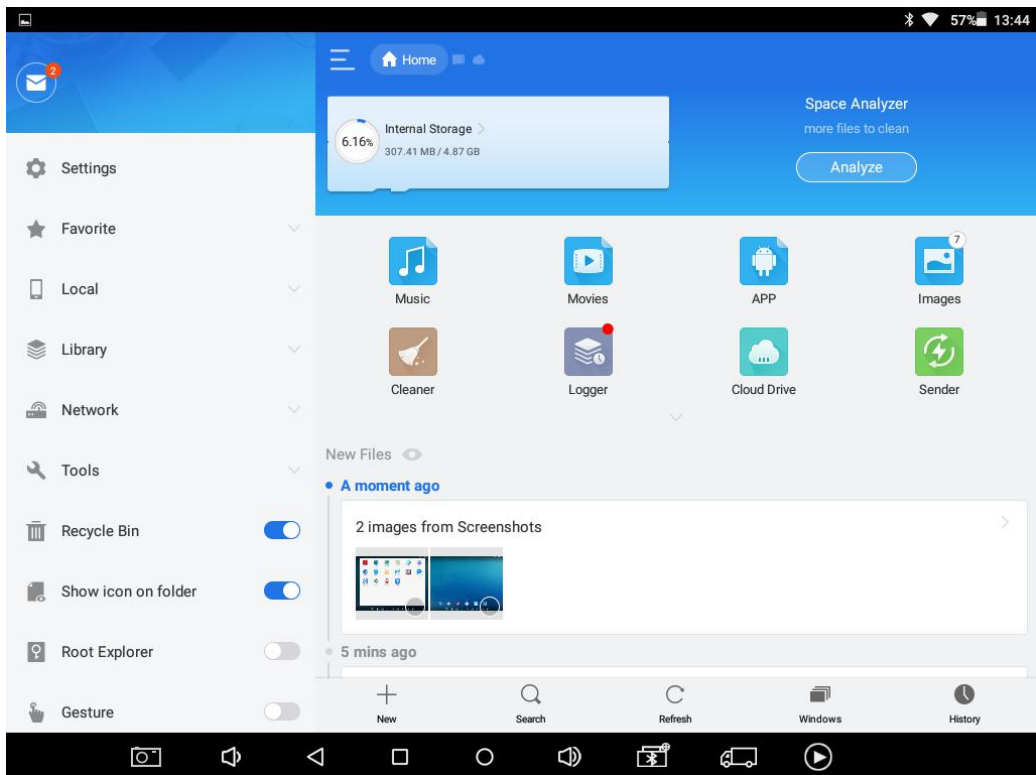

Fig 2-9

- e) **D8 Smart Diagnosis System:** The App allows you to diagnose your vehicle and offers a range of special maintenance services.

DIAGNOSIS SYSTEM ENTRANCE

Once activated, you will automatically enter the diagnostic system with the following main screen. Tap on diagnosis application button on the menu, the main interface will be shown as below:











Fig 2-10

The main interface is mainly composed of **Function Buttons** and **Navigation Buttons**. The touch screen navigation is menu-driven, and you can quickly access functions by clicking on the option title and answering the dialog window. A detailed description of the menu structure can be found in the next section **Function Buttons**.

FUNCTION BUTTONS

The following table briefly describes each function button







Table 2-2

Item	Description
	Quickly access to the vehicle system to identify the vehicle VIN code
	Enter to select vehicle
	Includes special functions for car diagnosis
	You can view the vehicle diagnostic report
	In case of failure, you can control the diagnostic equipment remotely
	Users can upgrade the upgradeable software with one click
	Users can set the language, unit, Bluetooth, repair shop information, also can view information about this software
	Users can view extended functions such as Xtool Cloud here

NAVIGATION BUTTONS

Instructions for operating the navigation bar buttons at the bottom of the screen, as described in the table below:

Table 2-3

Items	Descriptions
	Back to previous interface
	Back to the main interface of Android system
	Shows recently used applications
	Press for screenshot
	Increase volume
	Click here to return to diagnostic vehicle models interface
	Decrease volume

NOTIFICATION BAR

Slide down to open the notification bar. User can adjust the brightness of the screen when you need, and you can also connect Wi-Fi and so on.

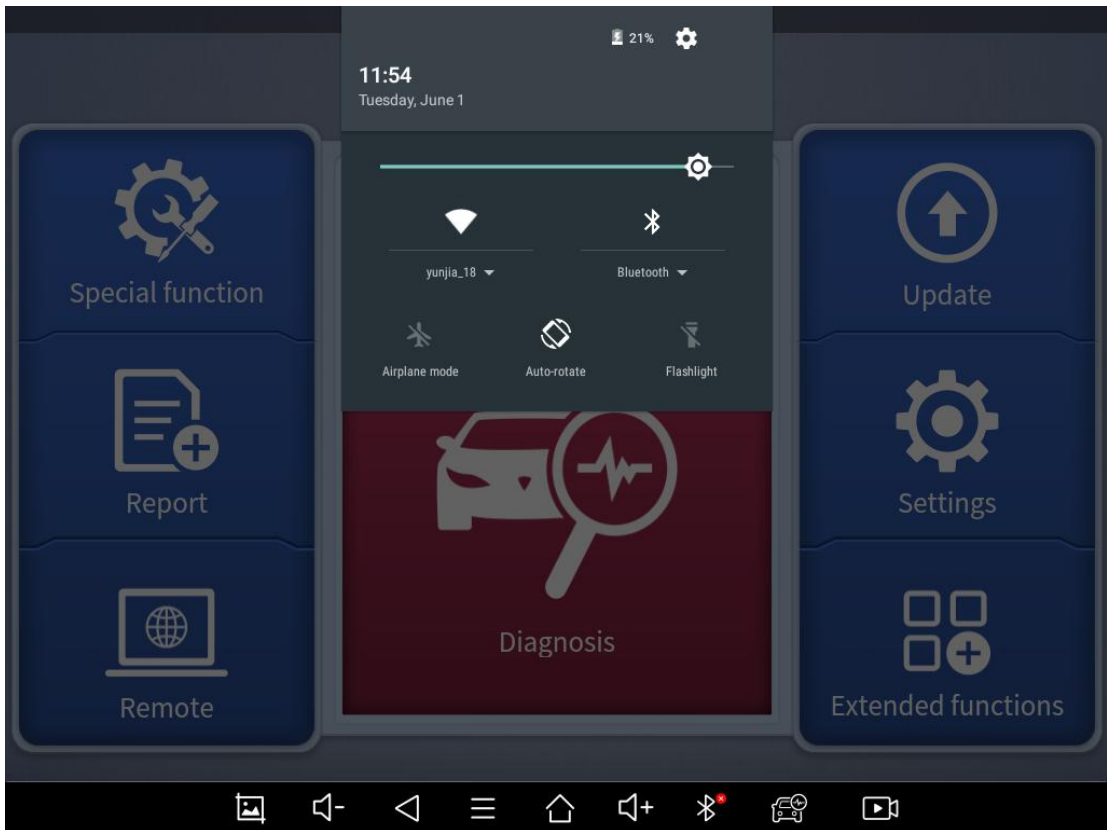

Fig 2-11

3 UPDATE

After activating the device, please update the software in "**Update**" first. The device will pull all currently supported software packages, and you can download them as needed. ALL software updates directly via the Internet. To access the update application, open the diagnosis application and click UPDATE, shown as below:

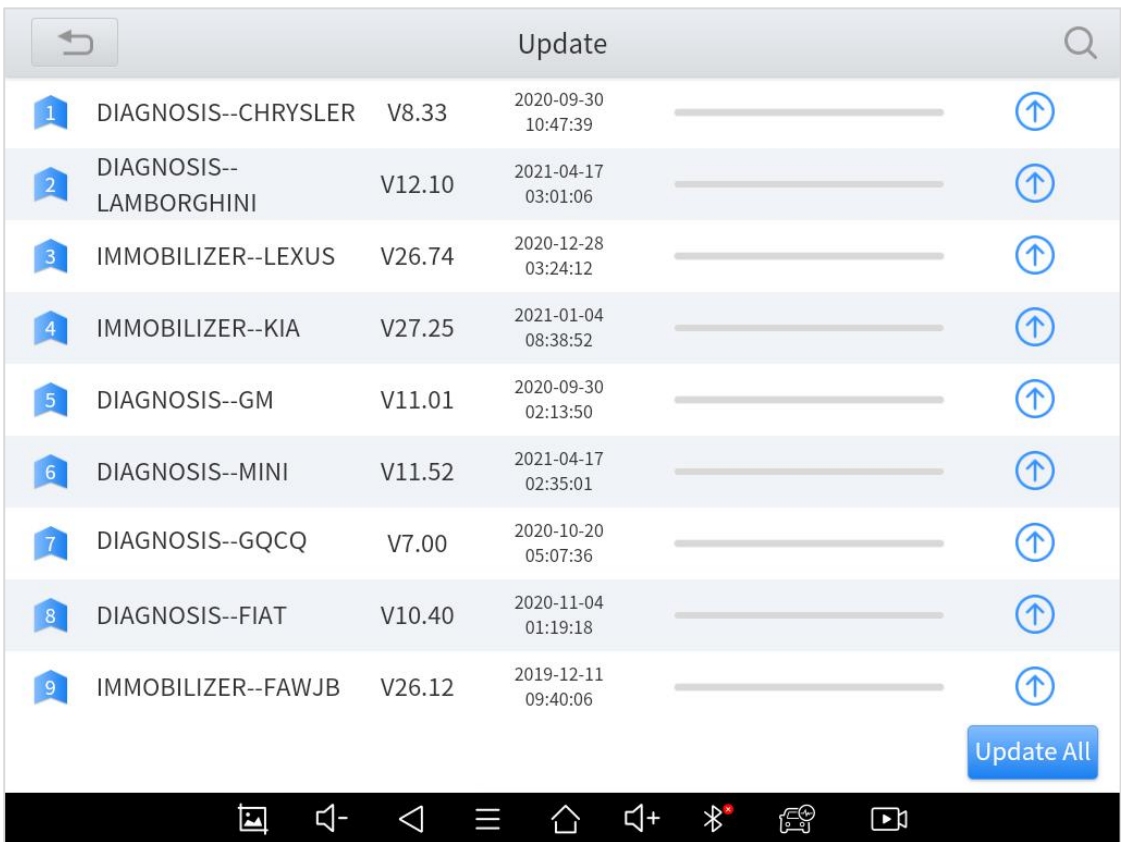

Fig 3-1

***Note**

- a) After activating the device for the first time, if you do not upgrade first, the diagnostic system will be blank.

4 DIAGNOSIS

The diagnostic application can read ECU information, read and clear DTC and check living data and freeze frames. The diagnosis application can access the electronic control unit (ECU) of various vehicle control systems, including the engine, transmission, anti-lock braking system (ABS), airbag system (SRS), and perform kinds of actuation tests.

VEHICLE CONNECTION

The diagnosis operation needs to connect the D8 smart diagnosis system to vehicle first, so that the tablet can establish correct vehicle communication. Please perform the following steps:

- 1 Turn on the tablet;
- 2 Connect cables and tablet in following order: ①→②→③→④;
- 3 Switch on the ignition and tap on Diagnosis application to test vehicles.

Since the display tablet and the VCI box are integrated, in order to communicate with the vehicle, the OBD II -16 connector must be connected to the main test cable, and the vehicle data connector should be inserted into the DLC usually located under the vehicle dashboard. The OBDII-16 adapter should be connected to the

vehicle, and the main test line should be connected to the OBDII-16 adapter and the tablet

The connection method is shown in the figure below:

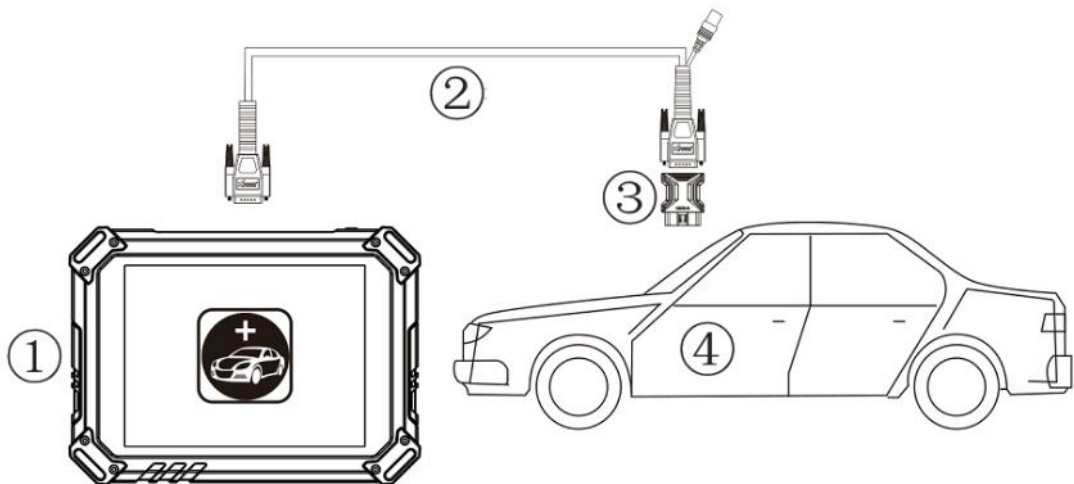

Fig 4-1

- ① Tablet
- ② Main Test Cable
- ③ OBDII-16 Connector
- ④ Vehicle

***Caution:** Please make sure all the cables are connected tightly; The vehicle's DLC is not always located under the dash; for the location of the DLC, please refer to the vehicle's user manual.

DIAGNOSIS

After the tablet device is properly connected to the vehicle, you could start the vehicle diagnosis.

VEHICLE SELECTION

The D8 intelligent diagnosis system supports the following 4 ways to access to the vehicle diagnosis system.

- AUTO SCAN
- SCAN CODE
- MANUAL ENTER
- SELECT VEHICLE BY AREA

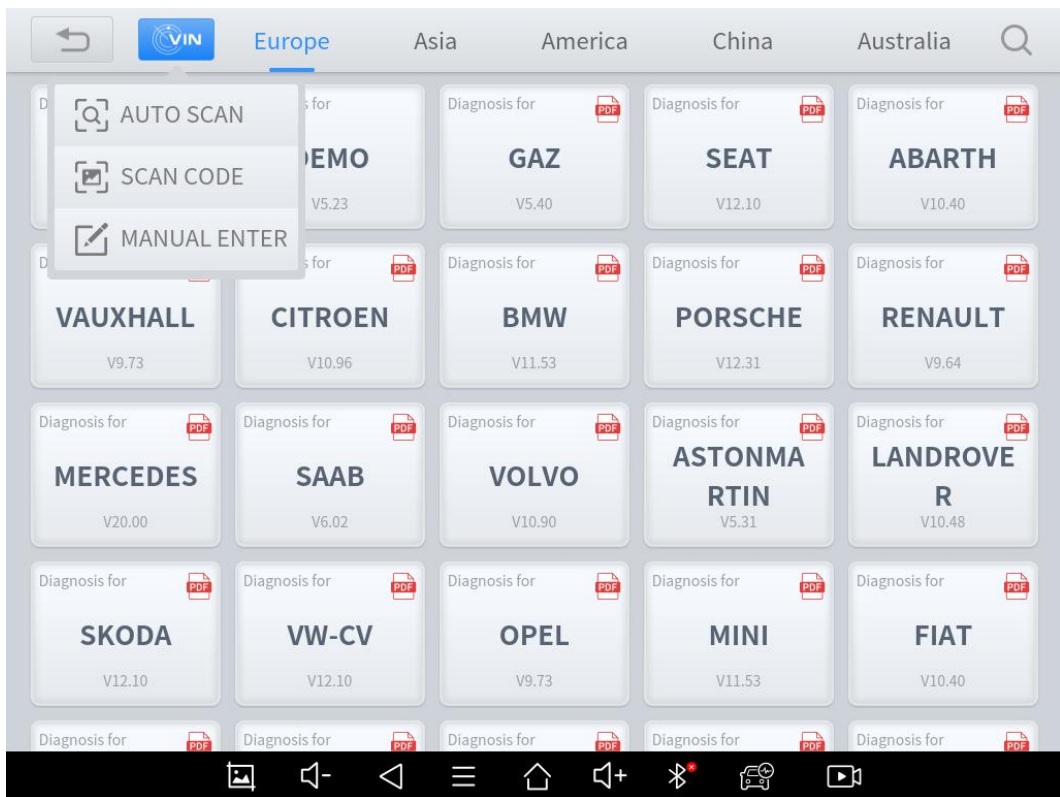

Fig 4-1

Click the VIN button in the upper left corner, you can choose to enter the vehicle diagnosis through the first 3 ways of **AUTO SCAN/SCAN CODE/MANUAL ENTER**.

- **AUTO SCAN:** It supports automatic reading of vehicle VIN code.

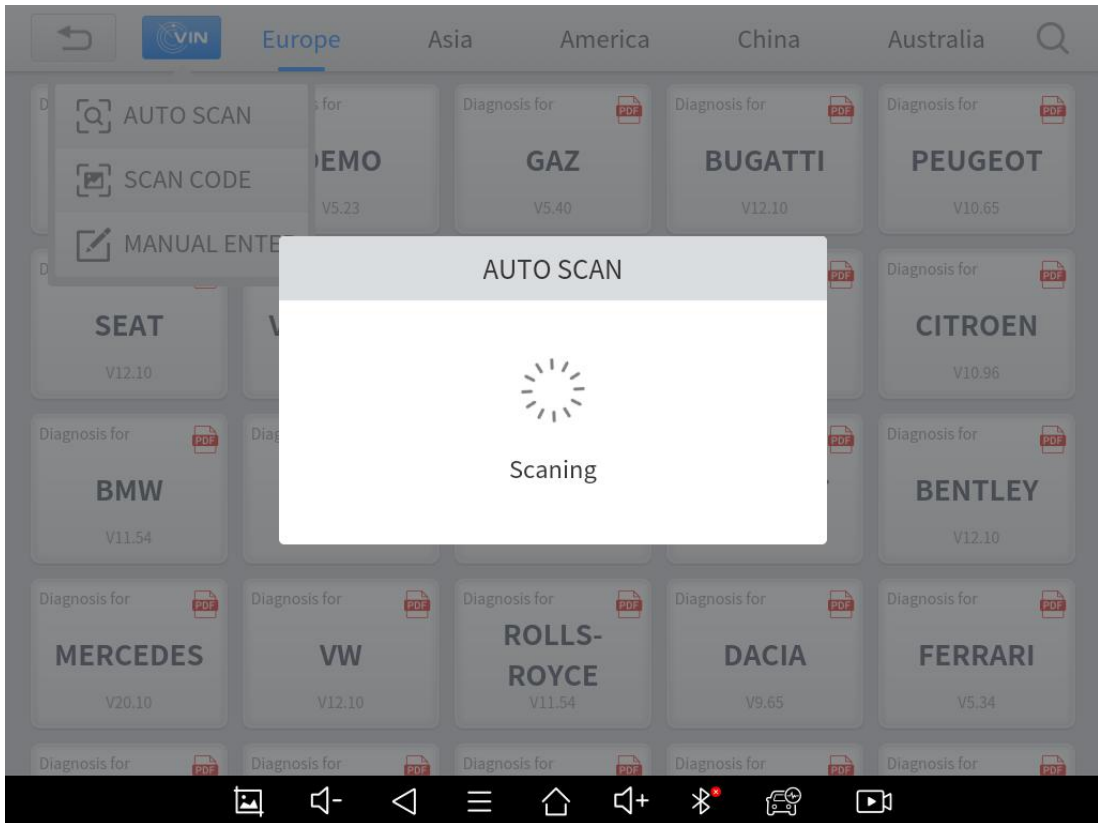

Fig 4-2

***Note**

- a) You also can tap on the button “**AUTO SCAN**” on diagnosis system entrance to use this function.
- b) Please make sure that the car and the device are well connected before using this function.

- **SCAN CODE:** It supports scanning the bar code on the vehicle nameplate through the camera to automatically read the VIN code.

***Note**

- a) When using this function, please make sure that the light is sufficient and the bar code is not obstructed;
- b) Please make sure the wireless network environment is stable.
- **MANUAL ENTER:** It supports manual input of car VIN code. When entering the VIN code manually, make sure that the 17 characters entered are correct to avoid reading failure.

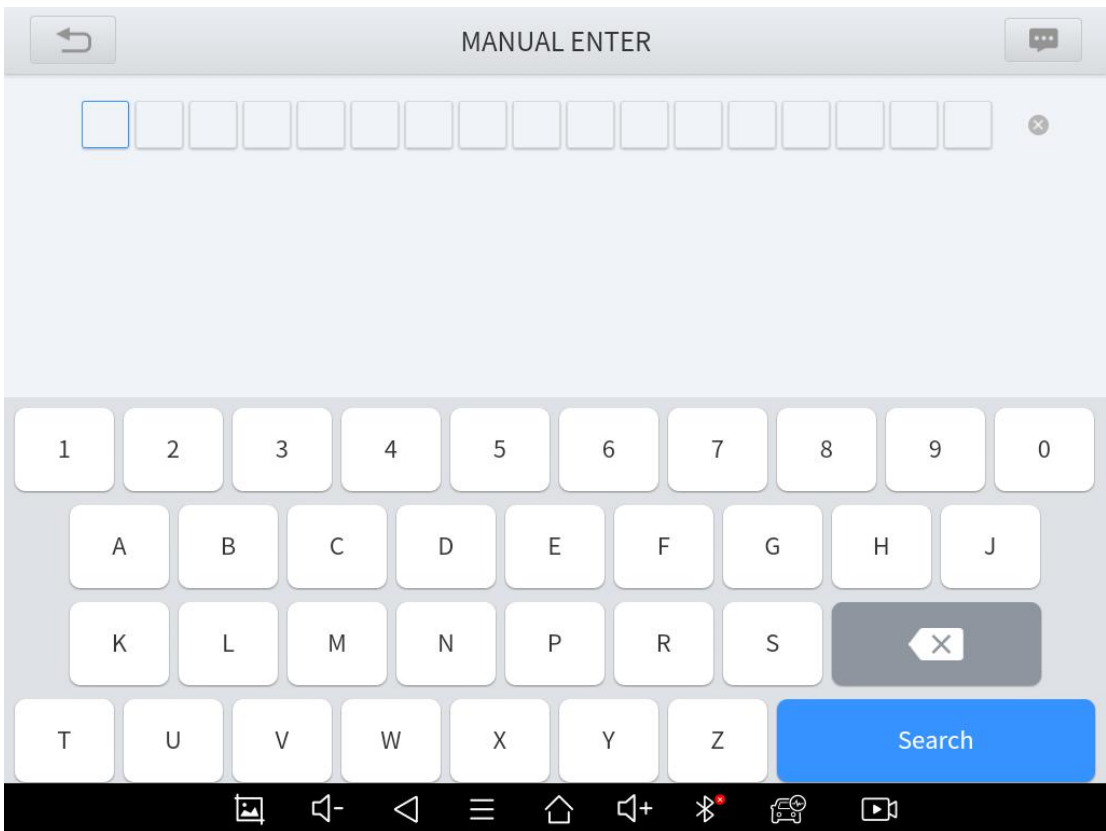

Fig 4-3

SELECT VEHICLE BY AREA

In addition to the above 3 methods, you can also choose a car brand according to the region. You can select the vehicle model that needs to be diagnosed according to the area, as shown below:

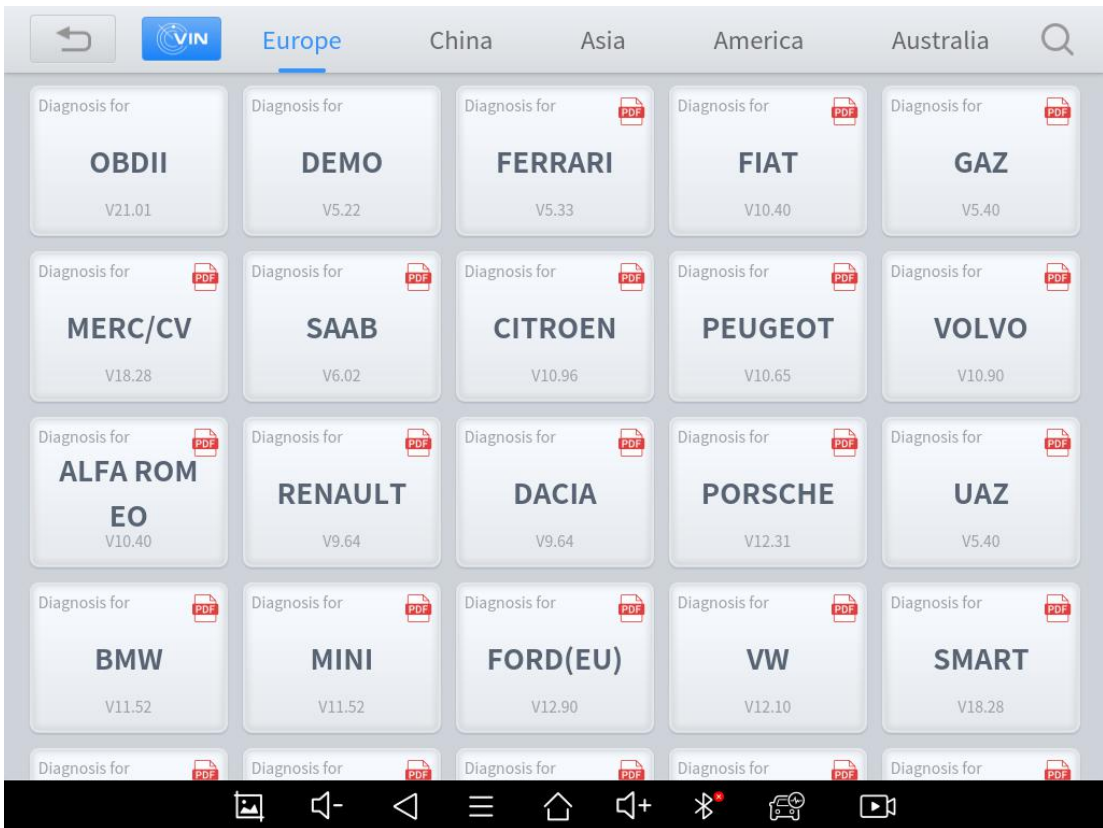

Fig 4-4

Some models provide multiple entry methods in the sub-menu, including **Automatic Detection**, **Manual Selection** and **System Selection**.

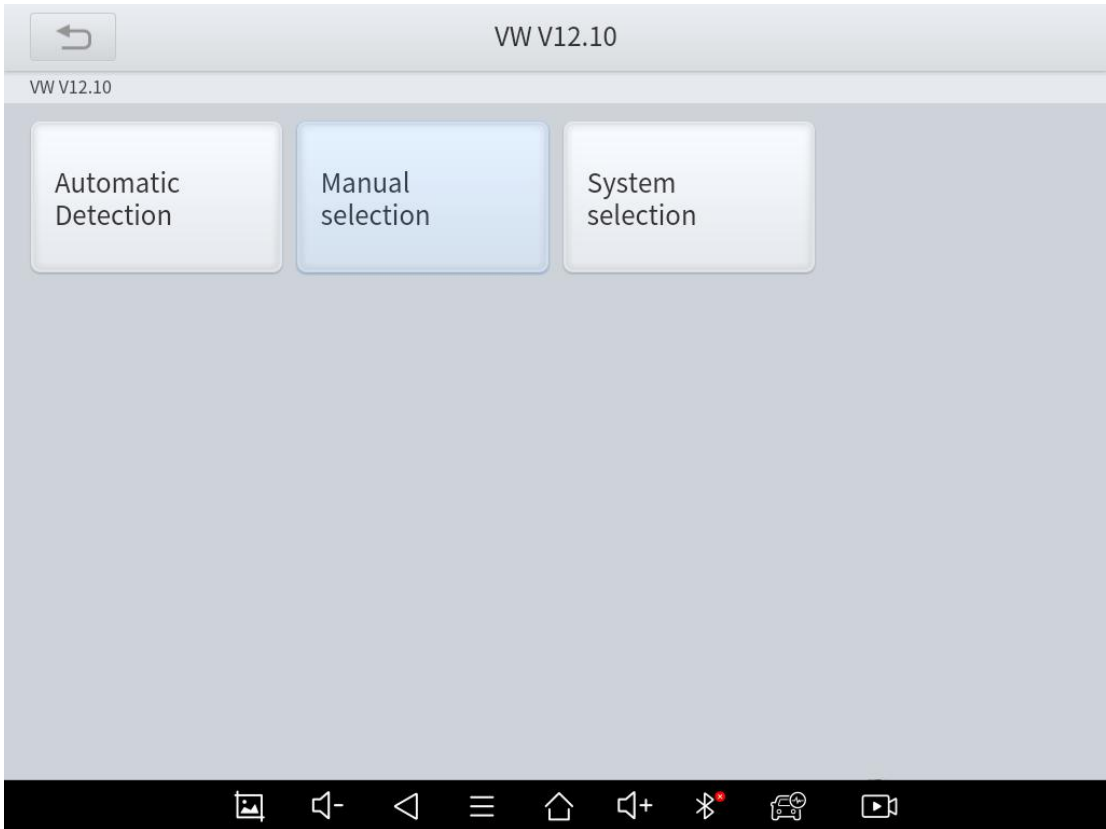

Fig 4-5

Automatic Detection will automatically identify the vehicle's VIN code, and then read the information of your target diagnostic object. If you choose "**Manual selection**", then you can continue to select the vehicle brand, year, and model of the vehicle in the sub-menu to diagnosis the vehicle. Enter "**System Selection**", you can also diagnose the vehicle according to the system according to your needs after selecting the model.

***Note**

- a) OBD II supports reading the common fault codes in the engine;
- b) DEMO, a demonstration program; Click this button to experience and learn the operation process of the diagnostic function;

- c) If you need to view the list of functions covered by the model, you can click the PDF icon at the top right of the model brand button.

BASIC FUNCTIONS

The diagnosis system supports 5 basic diagnosis functions, as follows:

- **Read ECU Information**
- **Read/Clear Trouble Code**
- **Read Live Data**
- **Actuation Test**
- **Frozen Frame**

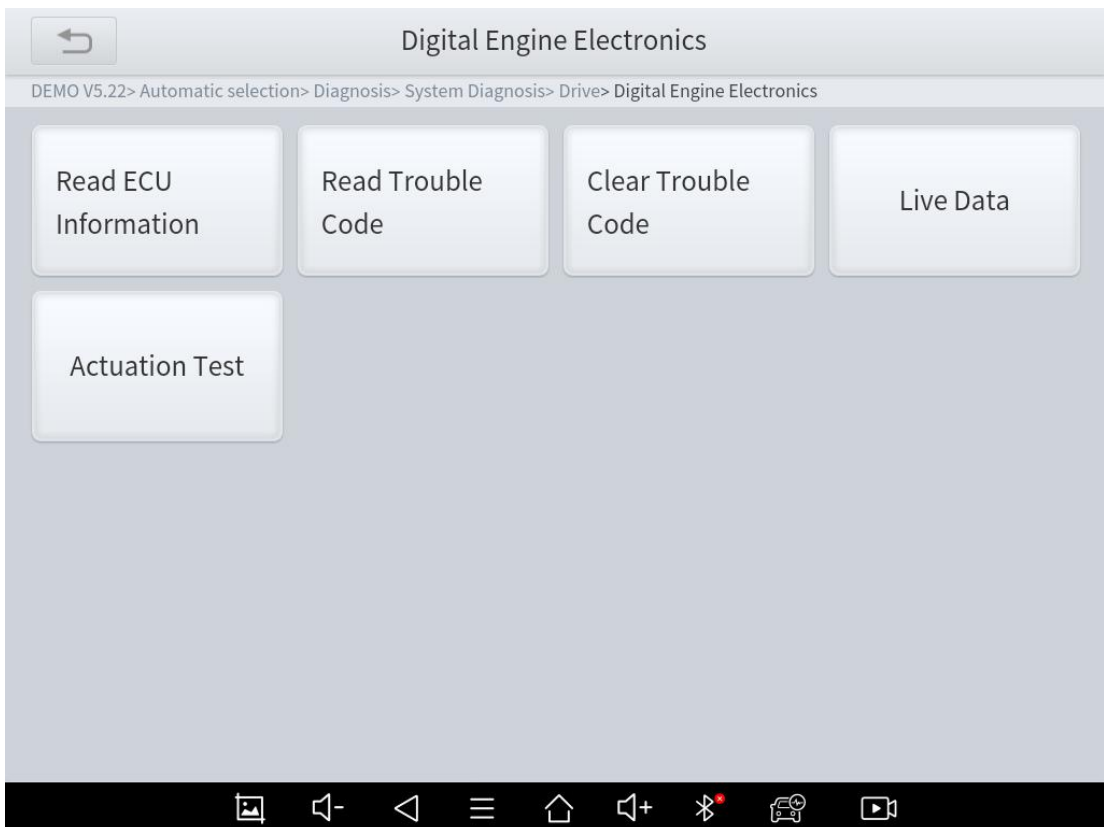

Fig 4-4

Read ECU Information: This function is to read ECU version information, which is the equivalent of "**System Identification**" or "**System information**" in some electronic control systems, all mean to read ECU related software and hardware versions, models and production date of diesel engine, part number, etc. It is convenient for us to make record in the maintenance process, and it also makes data feedback and management easier.

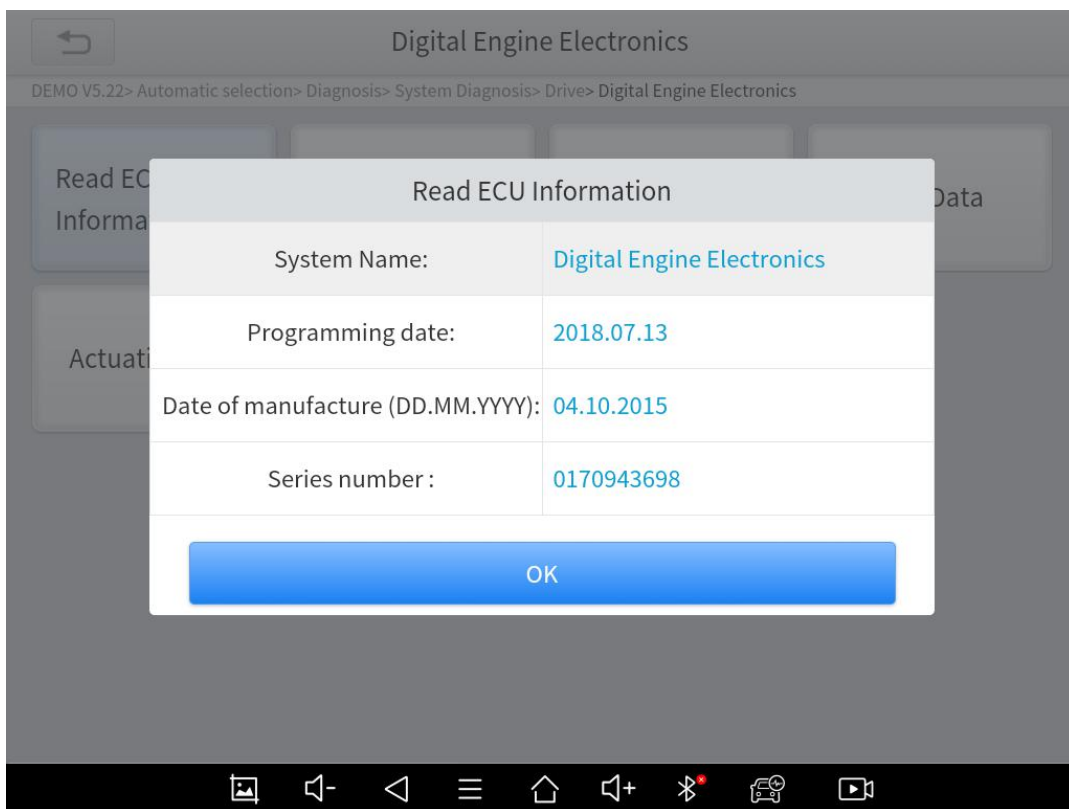

Fig 4-5

Read Trouble Code: Read trouble codes stored in ECU.

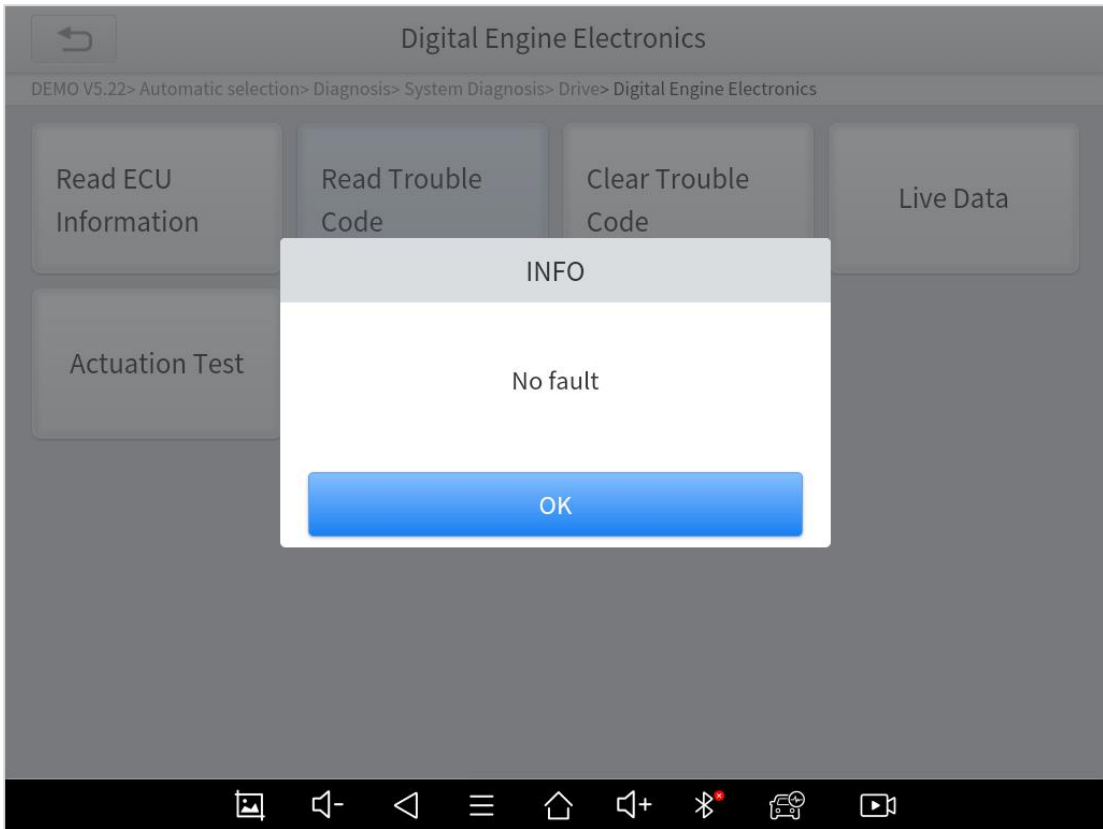

Fig 4-6

***Tip:** In the process of diagnosis, if the device shows “**System is OK**” or “**No Trouble Code**”, it means there is no related trouble code stored in ECU or some troubles are not under the control of ECU, most of these troubles are mechanical system troubles or executive circuit troubles, it is also possible that signal of the sensor may bias within limits, which can be judged in Live Data.

Clear Trouble Code: It allows to clear current and historical trouble codes memory in ECU, under the premise that all the troubles are eliminated.

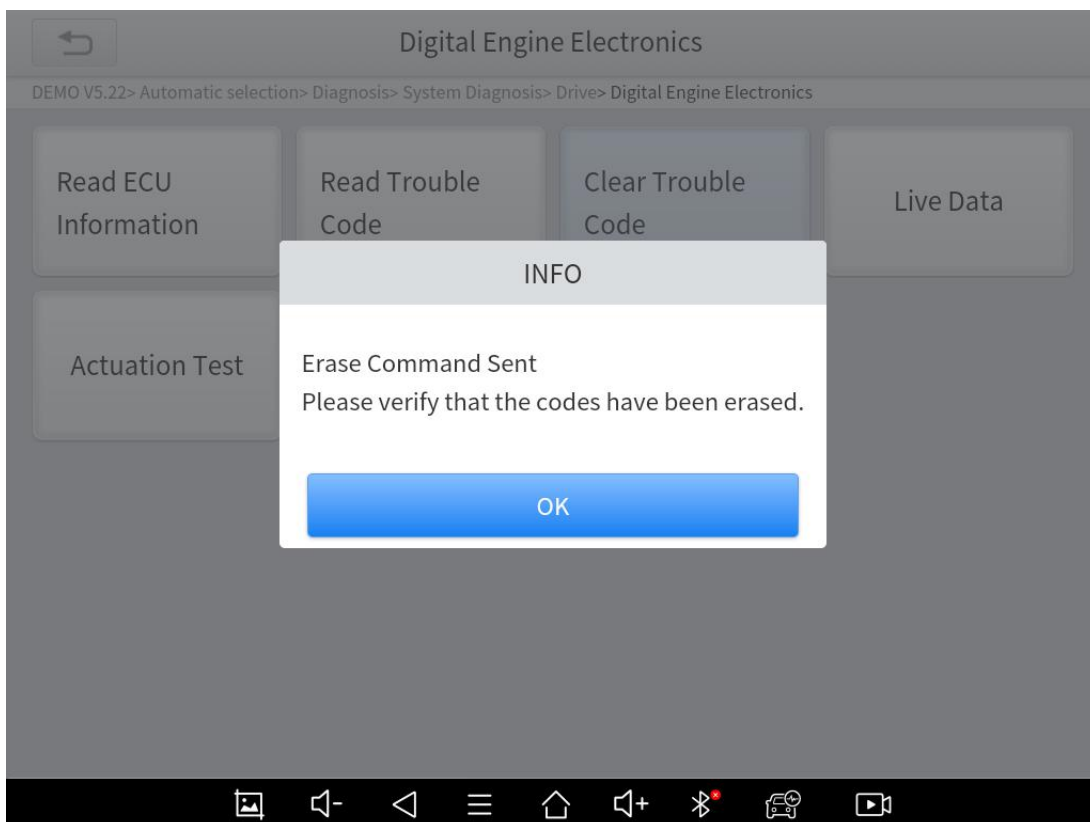

Fig 4-7

The trouble codes can't be erased without eliminating all the troubles, which will cause the diagnostic tool always reading the trouble code because the code will always be saved in ECU. Suggestion: users should better not to clear trouble codes, we need record the trouble details after reading code, which is provided as reference for maintenance. After dealing with troubles, there will be no trouble code when we re-read.

Read Live Data: that is to read the parameters of running engine, such as oil pressure, temperature, engine speed, fuel oil temperature, coolant temperature, intake air temperature, etc. Based on these parameters, we can judge directly where the problem lies, which helps to narrow the scope in maintenance. For some vehicles, during their actual operation, the problems such as performance characteristics offset, sensitivity reduction, can be judged in live data.

NO.	Name	Value	Unit
1	Engine speed	44.00	1/min
2	Coolant temperature	-48.00	degree C
3	Engine oil temperature	49083.75	degree C
4	Emissions warning light: Status	2	
5	Emissions warning light: Distance travelled since activation	N/A	km
6	Status, engine warning light	255	
7	Operating time since engine start	250.30	s
8	Operating hour counter	5160.00	min

Fig 4-8

In the process of diagnosis, if the device shows “**System is OK**” or “**No Trouble Code**”, it means there is no related trouble code

stored in ECU or some troubles are not under the control of ECU, most of these troubles are mechanical system troubles or executive circuit troubles, it is also possible that signal of the sensor may bias within limits, which can be judged in Live Data.

Actuation Test: mainly to judge whether these actuating components of engine are working properly.

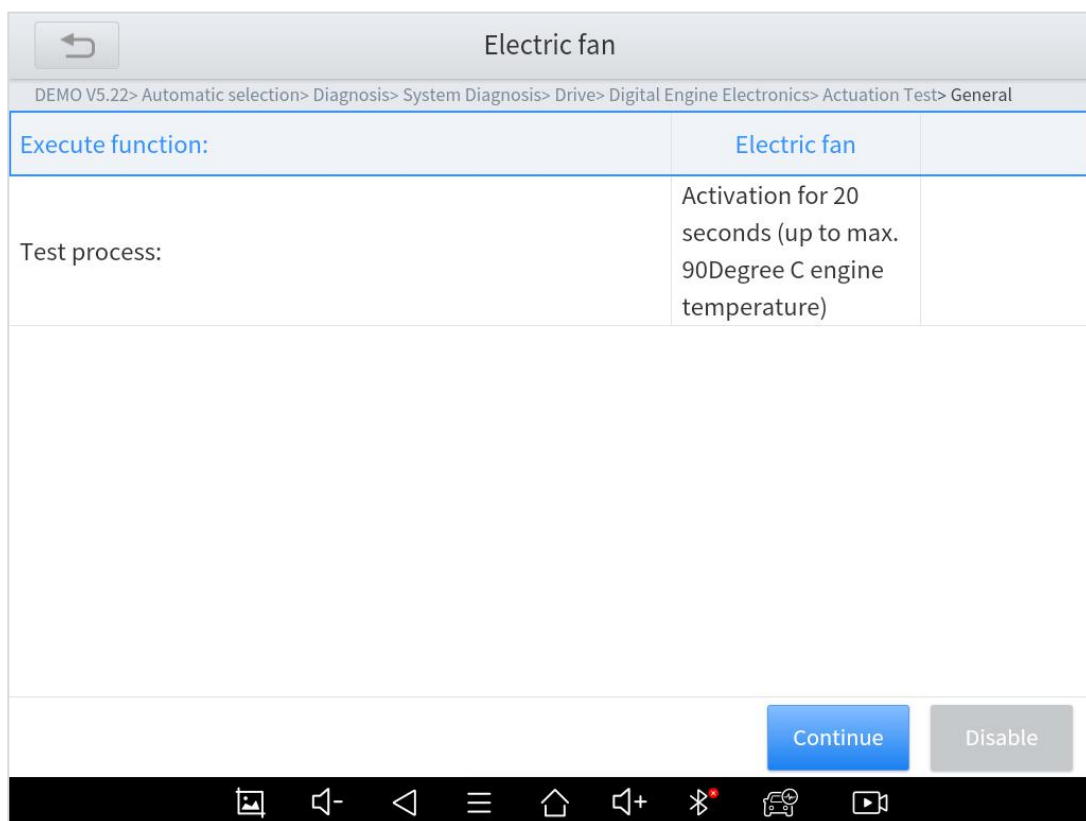

Fig 4-9

Frozen Frame: When the signal of the sensor is abnormal, the ECU will save the data at that moment of failure to form a frozen frame. It is usually used to analyze the reasons that may lead to car failures.

The living data items supported by vehicles of different brands are not exactly the same, so the frozen frames displayed when diagnosing vehicle of different brands may also be different. Some vehicles may not have the option of frozen frame, because the model does not support this function.

5 SPECIAL FUNCTIONS

The D8 Smart Diagnosis System supports 23 commonly used special reset functions, allowing you to quickly access your vehicle system for various scheduled services, maintenance and reset performance, eliminating the need to reset after resolving common problems. This user manual lists some of the commonly used special reset services for your reference. The special functions interface is shown as below:

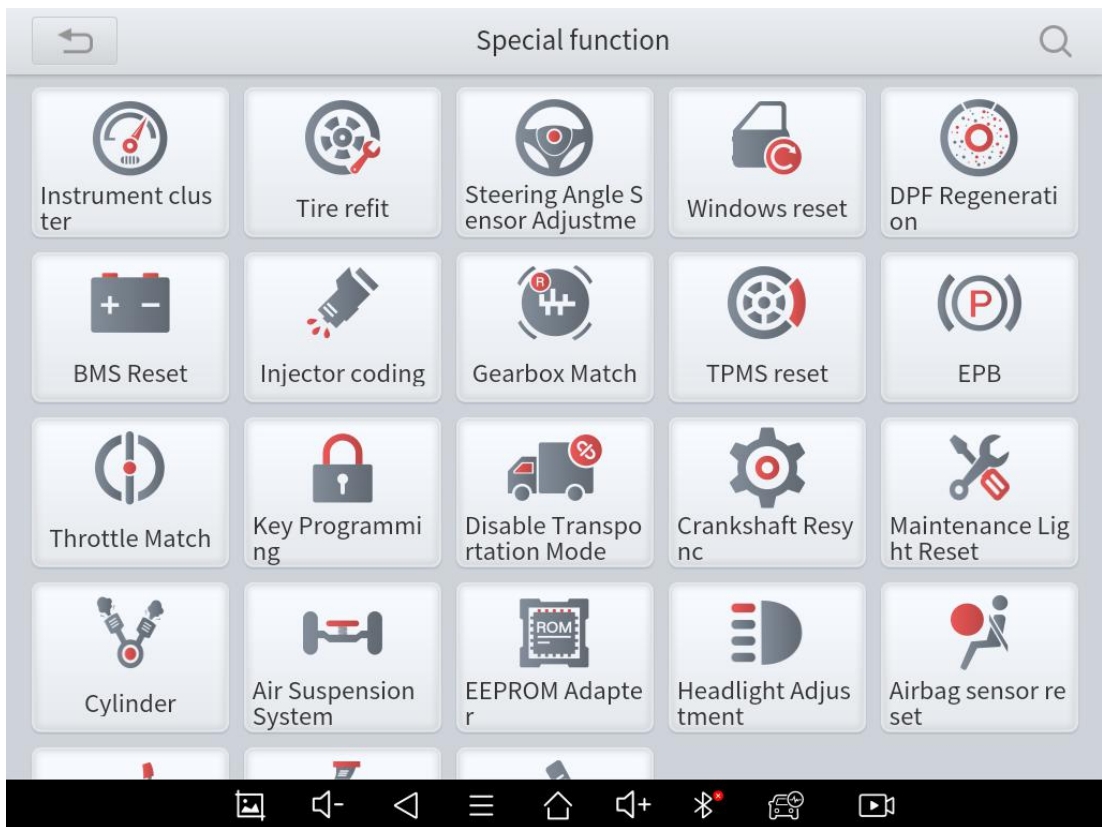

Fig 5-1

*Note:

- a) Due to the limitation of screenshots, the special functions shown in this picture are not complete.
- b) All special functions supported by D8 are subject to the actual special functions displayed on the device.

KEY PROGRAMMING

An immobilizer is an anti-theft mechanism that prevents a vehicle's engine from starting unless the correct ignition key or other device is present. Most new vehicles have an immobilizer as standard equipment. An important advantage of this system is that it doesn't require the car owner to activate it since it operates automatically. An immobilizer is considered as providing much more effective anti-theft protection than an audible alarm alone.

As an anti-theft device, an immobilizer disables one of the systems needed to start a car's engine, usually the ignition or the fuel supply. This is accomplished by radio frequency identification between a transponder in the ignition key and a device called a radio frequency reader in the steering column. When the key is placed in the ignition, the transponder sends a signal with a unique identification code to the reader, which relays it to a receiver in the vehicle's tablet control module. If the code is correct, the tablet allows the fuel supply and ignition systems to operate and start the car. If the code is incorrect or absent, the tablet disables the system, and the car will be unable to start until the correct key is placed in the ignition.

To prevent the car being used by unauthorized keys, the anti-theft key matching function must be performed so that the immobilizer control system on the car identifies and authorizes remote control keys to normally use the car.

When the ignition switch key, ignition switch, combined instrument panel, ECU, BCM, or remote-control battery is replaced, anti-theft key matching must be performed.

The Key Programming service can disable a lost vehicle key and program the replacement key fob. One or more replacement key fobs can be programmed.

***Note**

- a) Some models need to be used with EEPROM adapter for IMMO service.
- b) The EEPROM adapter is not included in this product.
- c) Please purchase it separately if you need it.

EEPROM ADAPTER

The EEPROM adapter can read the car anti-theft password, back up, read and write and restore anti-theft data, and flash ECU data. Usually, this function is used in conjunction with IMMO or ODO reset.

***Note**

- a) The EEPROM adapter is not included in this product. Please purchase it separately if you need it.

EPB RESET

Electronic Parking Brake (EPB) System reset is a popular special function. You can use this function to reset the electronic parking brake system and brake pads, which also supports the brake pad replacement (retraction, release of the brake pump), G-sensor and body angle calibration. This function has multiple uses and can safely and effectively maintain the electronic brake system. These applications include deactivating and activating brake control systems, assisting in controlling brake fluid, opening and closing brake pads, and setting brakes after replacing brake discs or brake pads, etc.

1. If the brake pad wears the brake pad sense line, the brake pad sense line sends a signal sense line to the on-board tablet to replace the brake pad.

After replacing the brake pad, you must reset the brake pad. Otherwise, the car alarms.

2. Reset must be performed in the following cases:

- The brake pad and brake pad wear sensor are replaced.
- The brake pad indicator lamp is on.
- The brake pad sensor circuit is short, which is recovered.
- The servo motor is replaced.

OIL LIGHT RESET

Reset the Engine Oil Life System, which calculates the optimum oil life change interval based on the vehicle's driving conditions and climate. The oil life reminder must be reset each time the oil is changed so that the system can calculate when the next oil change is required.

This function allows you to perform reset for the engine oil life system, which calculates an optimal oil life change interval depending on the vehicle driving conditions and climate.

This function can be performed in the following cases:

- If the service lamp is on, you must provide service for the car. After service, you need to reset the driving mileage or driving time so that the service lamp turns off and the system enables the new service cycle.
- After changing engine oil or electric appliances that monitor oil life, you need to reset the service lamp.

SAS RESET

Steering Angle Sensors (SAS) System Calibration permanently stores the current steering wheel position as the straight-ahead position in the SAS EEPROM. Therefore, the front wheels and the steering wheel must be set exactly to the straight-ahead position

before calibration. In addition, the VIN is also read from the instrument cluster and stored permanently in the SAS EEPROM. On successful completion of calibration, the SAS fault memory is automatically cleared.

To reset the steering angle, first find the relative zero-point position for the car to drive in straight line. Taking this position as reference, the ECU can calculate the accurate angle for left and right steering.

After replacing the steering angle position sensor, replacing steering mechanical parts (such as steering gearbox, steering column, end tie rod, steering knuckle), performing four-wheel alignment, or recovering car body, you must reset the steering angle.

TPS MATCH

Throttle Position Sensor (TPS) Match, this function enables you to make initial settings to throttle actuators and returns the “learned” values stored on ECU to the default state. Doing so can accurately control the actions of regulating throttle (or idle engine) to adjust the amount of air intake.

INJECTOR CODING

This function can write the identification code of the fuel injector into the ECU so that the ECU can recognize and work normally.

Write injector actual code or rewrite code in the ECU to the injector code of the corresponding cylinder so as to more accurately control or correct cylinder injection quantity.

After the ECU or injector is replaced, injector code of each cylinder must be confirmed or re-coded so that the cylinder can better identify injectors to accurately control fuel injection.

***Note**

- a) After cleaning, generally there is no need to do the coding matching function.
- b) The identification of the fuel injector includes its working accuracy value and type value. When replacing it, you need to find the corresponding model for replacement.
- c) At present, mainstream cars support injector coding function

ABS BLEEDING

Anti-lock Braking System (ABS) Bleeding allows you to perform various bi-directional tests to check the operating conditions of ABS.

1. When the ABS contains air, the ABS bleeding function must be performed to bleed the brake system to restore ABS brake sensitivity.
2. If the ABS tablet, ABS pump, brake master cylinder, brake cylinder, brake line, or brake fluid is replaced, the ABS bleeding function must be performed to bleed the ABS.
3. After the oil in the brake oil tank is seriously insufficient or the brake fluid is replaced, ABS Bleeding is also required

***Note**

- a) When performing ABS Bleeding, it is necessary to unscrew the exhaust screw of the ABS pump.
- b) After completing the tire pressure sensor learning, it takes a while for the fault light to go out.
- c) Tire pressure imbalance will also cause the tire pressure light to light up.

GEARBOX MATCH

After changing the gearbox or changing the gearbox ECU, you need to use the gearbox matching function to re-match the engine and the gearbox.

***Cautions!**

Before resetting the gearbox, please check the gearbox control unit to ensure that there is no fault code. If there is a fault code, the gearbox memory function cannot be reset. Please road test after reset.

GEAR LEARNING

The crankshaft position sensor learns crankshaft tooth machining tolerance and saves to the tablet to more accurately diagnose engine misfires. If tooth learning is not performed for a car equipped with Delphi engine, the MIL turns on after the engine is started. The diagnostic device detects the DTC P1336 'tooth not learned'. In this case, you must use the diagnostic device to perform tooth learning for the car. After tooth learning is successful,

the MIL turns off. This function can complete the self-learning of the gearbox and improve the quality of shifting.

After the engine ECU, crankshaft position sensor, or crankshaft flywheel is replaced, or the DTC 'tooth not learned' is present, tooth learning must be performed.

SRS RESET

Supplemental Restrgint System (SRS) Reset allows you resets the airbag data to clear the airbag collision fault indicator. Generally, SRS reset is required after airbag replacement

DPF REGENERATION

The Diesel Particle Filter (DPF) function manages DPF regeneration, DPF component replacement teach-in and DPF teach-in after replacing the engine control unit.

The ECM monitors driving style and selects a suitable time to employ regeneration. Cars driven a lot at idling speed and low load will attempt to regenerate earlier than cars driven more with higher load and speed. For regeneration to take place, a prolonged high exhaust temperature must be obtained.

In the event of the car being driven in such a way that regeneration is not possible, i.e., frequent short journeys, a diagnostic trouble code will eventually be registered in addition to

the DPF light and “Check Engine” indicators displaying. A service regeneration can be requested in the workshop using the diagnostic tool.

DPF regeneration is used to clear PM (Particulate Matter) from the DPF filter through continuous combustion oxidation mode (such as high temperature heating combustion, fuel additive or catalyst reduce PM ignition combustion) to stabilize the filter performance.

DPF regeneration may be performed in the following cases:

- The exhaust back pressure sensor is replaced.
- The PM trap is removed or replaced.
- The fuel additive nozzle is removed or replaced.
- The catalytic oxidizer is removed or replaced.
- The DPF regeneration MIL is on and maintenance is performed.
- The DPF regeneration control module is replaced.

BMS MATCH

The Battery Management System (BMS) allows the scan tool to evaluate the battery charge state, monitor the close-circuit current, register the battery replacement, and activate the rest state of the vehicle.

This function enables you to perform a resetting operation on the monitoring unit of vehicle battery, in which the original low battery fault information will be cleared and battery matching will be done.

Battery matching must be performed in the following cases:

- Main battery is replaced. Battery matching must be performed to clear original low battery information and prevent the related control module from detecting false information. If the related control module detects false information, it will invalidate some electric auxiliary functions, such as automatic start & stop function, sunroof without one-key trigger function, power window without automatic function.
- Battery monitoring sensor. Battery matching is performed to re-match the control module and monitoring sensor to detect battery power usage more accurately, which can avoid an error message displaying on the instrument panel.

AIR SUSPENSION

This function can adjust the height of the vehicle body. When replacing the body height sensor in the air suspension system, or control module or when the vehicle level is incorrect, you need to perform this function to adjust the body height sensor for level calibration.

The air suspension system reset function enables the tablet ECU to match the current air suspension system information, thereby ensuring the normal damping effect of the vehicle when driving.

Application scenarios:

- The shock absorber is not the same height due to air leakage, maintenance, replacement, etc.;
- After replacing the air pump assembly;
- After replacing the control tablet ECU.

CYLINDER

This function is suitable for power balance after replacing and repairing the cylinder.

TPMS RESET

Tire Pressure Monitor System (TPMS) Reset allows you to quickly look up the tire sensor IDs from the vehicle ECU, as well as to perform TPMS replacement and reset procedures after tire sensors are replaced.

This function allows you to quickly look up the tire sensor IDs from the vehicle's ECU, as well as to perform TPMS replacement and sensor test.

- After the tire pressure MIL turns on and maintenance is performed, the tire pressure resetting function must be performed to reset tire pressure and turn off the tire pressure MIL.
- Tire pressure resetting must be performed after maintenance is performed in the following cases: tire pressure is too low, tire leaks, tire pressure monitoring device is replaced or installed,

tire is replaced, tire pressure sensor is damaged, and tire is replaced for the car with tire pressure monitoring function.

TYRE REFIT

This function is used to set the size parameters of refitting or replacing tires.

HEAD ADJUSTMENT

This function is used to initialize the adaptive headlight system. It refers to the adaptive front lighting system (when using bi-xenon headlights at night), it can be rotated to the sides, pressing the button means that they remain direct, and do not turn when you turn. After replacing the headlights, the adaptive headlight system needs to be matched.

WINDOWS INITIALIZATION

This function is to match the windows to restore the initial memory of the ECU and restore the automatic raising and lowering functions of the power window. Usually when the vehicle window fails or after replacing the window glass, we need to use this function to initialize the car window.

SEAT MATCH

This function is suitable for the matching of replacement and maintenance seats with memory function. After the seat fails or is replaced or repaired, it is generally necessary to use this function to match the seat.

***Note**

Needed for cars with seats with memory function, general gasoline cars don't need.

ELECTRONIC PUMP ACTIVATION

Use this function to activate the electronic water pump before venting the cooling system.

TRANSPORT MODE

In order to reduce power consumption, the following functions may be disabled, including limiting the vehicle speed, not waking up the door opening network, and disabling the remote-control key, etc. At this time, the transport mode needs to be deactivated to restore the vehicle to normal.

DIY MODE

When a car with a high-level configuration and a car with a low-level configuration share the same ECU, or you need to change or add some features unique to the high-end vehicles, you can use

this function to support the activation of the hidden functions of the car (except those that are not supported by the hardware). Different hidden functions may require different operation steps, please be sure to operate under the guidance.

Cautions!

- The functions that the original ECU must support can be flashed out.
- Brushing to hide will not destroy the ECU system layer, but only open and close some functions.
- Most of them can be re-flashed multiple times.

Support cars:

Volkswagen, Toyota, BMW, Ford, Mazda

ODO RESET

This function allows you to copy, write or rewrite the kilometers in the odometer chip by using the car diagnostic tablet and data cable, so that the odometer can display the actual mileage.

*Some models need to be used with EEPROM adapter for ODO reset. The EEPROM adapter is not included in this product.

Please purchase it separately if you need to use i

6 SETTINGS



Fig 6-1

Click the Settings button to adjust the default settings and view information about the D8 Smart Diagnosis System. There are seven options available in the system settings:

- **Language**
- **Units**
- **My Workshop Info**
- **VCI Info**
- **About**

LANGUAGE

Select the language. Please choose the right language from the multi-language options on the right.

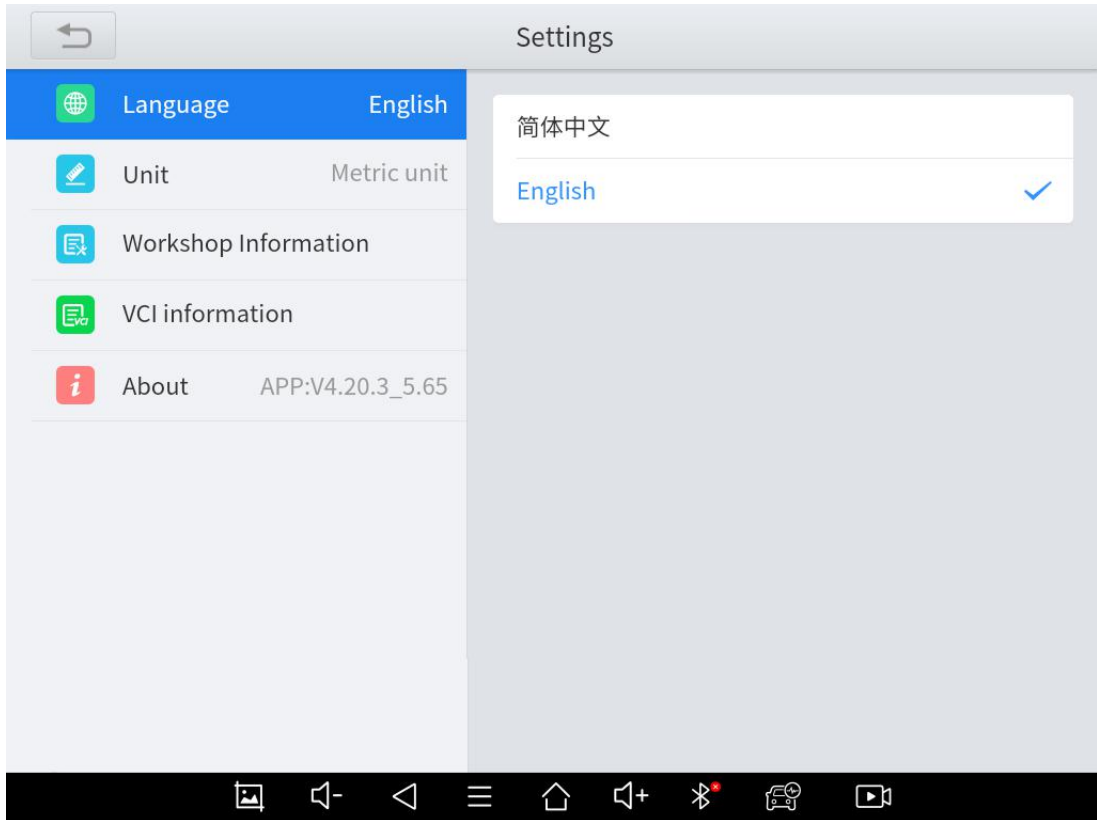

Fig 6-2

*Note

- a) The types and quantities of languages supported are subject to the actual language types displayed on the device

UNITS

You can switch the unit used by the system. D8 Smart Diagnosis System provides you with metric and imperial units. You can directly click on the unit when you need, after the switch is

successful, a blue check mark will be shown behind the unit's name.

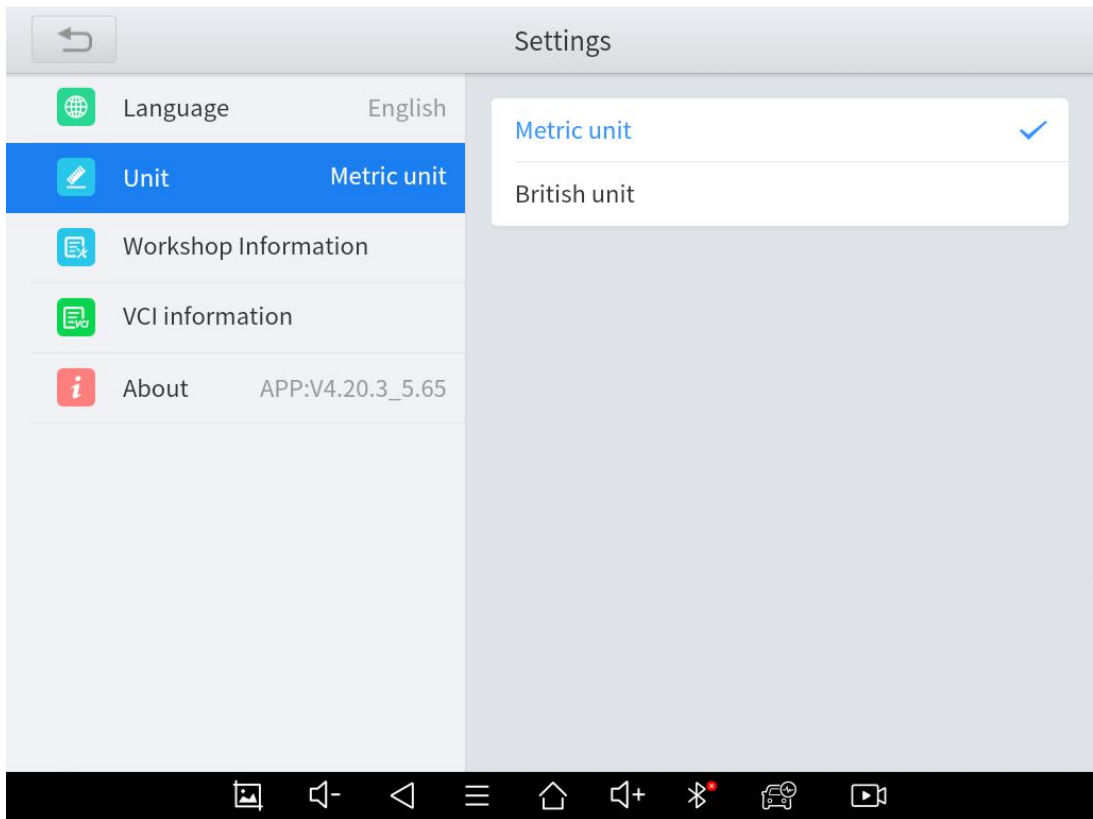

Fig 6-3

MY WORKSHOP INFO

Click on **My Workshop Information**, you can input your workshop information here. As shown in the figure below, you just need to fill in the valid information in the corresponding column and click "**SUBMIT**". And then it will show your workshop information in the report when you generate a diagnostic report, including your company name, address, website, telephone, and mailbox.

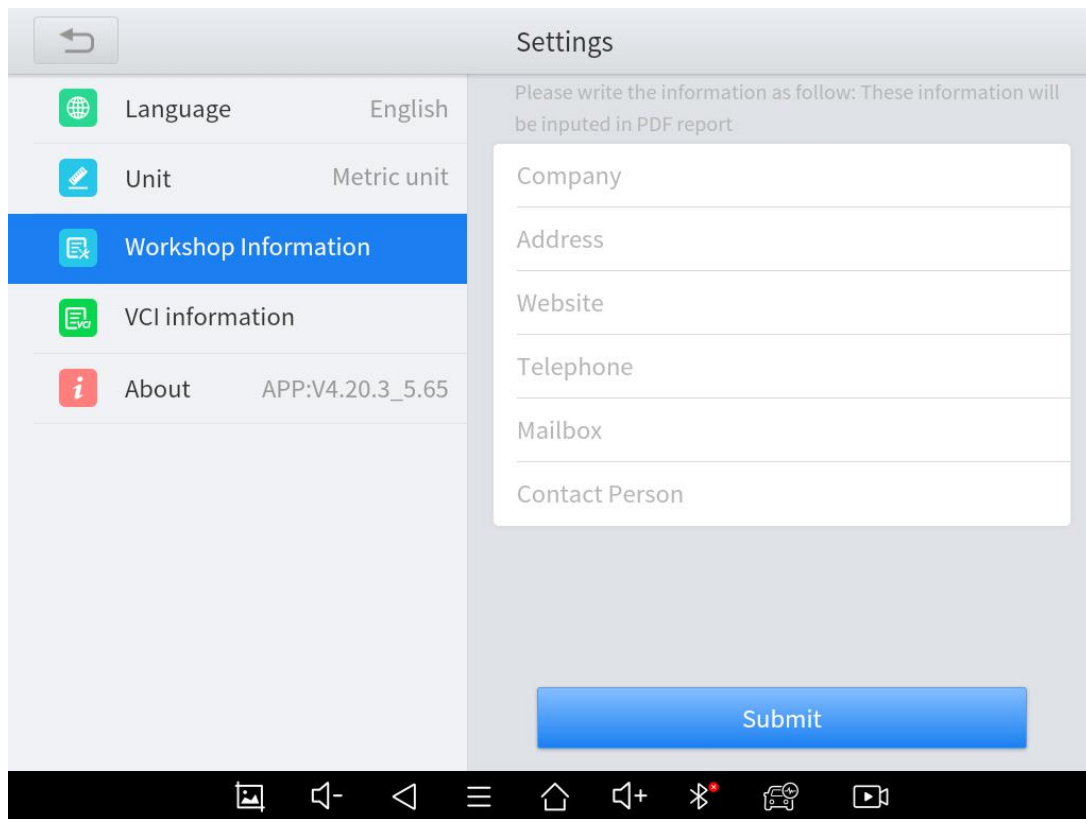

Fig 6-4

VCI INFORMATION

You can view the VCI information here, including the VCI firmware name, the latest firmware version, the currently used firmware version, and the VCI firmware type. If the current firmware version is lower than the latest firmware version, you can choose to update your firmware version and click **"Update VCI Firmware"** to complete the operation.

*Note

- a) Before updating the VCI Firmware, please ensure the tablet's connection to the Internet is stable.

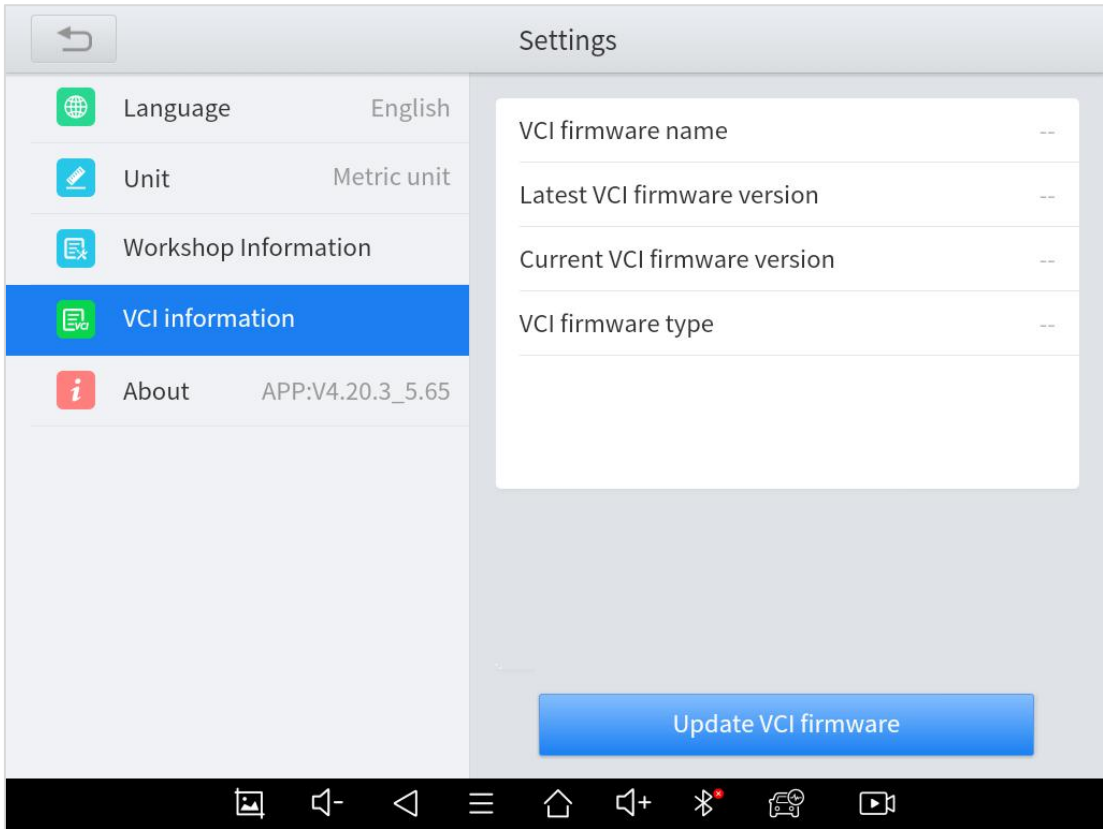

Fig 6-5

ABOUT

Tap on **ABOUT**, you can check the serial number and APP version on here.

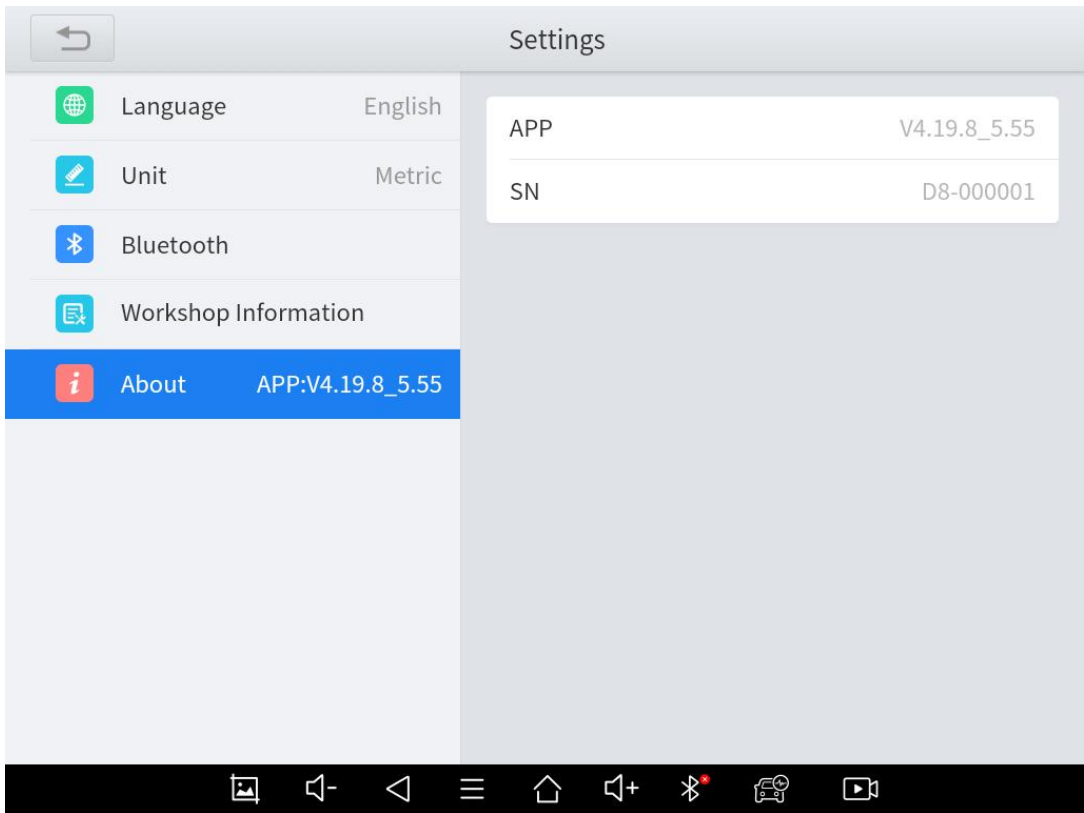

Fig 6-6

7 REPORT

Diagnostic Report is used for viewing and printing the saved files, such as Live Data, Trouble codes or pictures generated in the process of diagnosis, users also can view a record of which cars have been previously tested. It includes 3 parts:

- **Report**
- **Replay**
- **File Management**



Fig 7-1

REPORT

This feature provides a history of diagnostic reports, where you can view and delete the vehicle's diagnostic reports according to your needs.

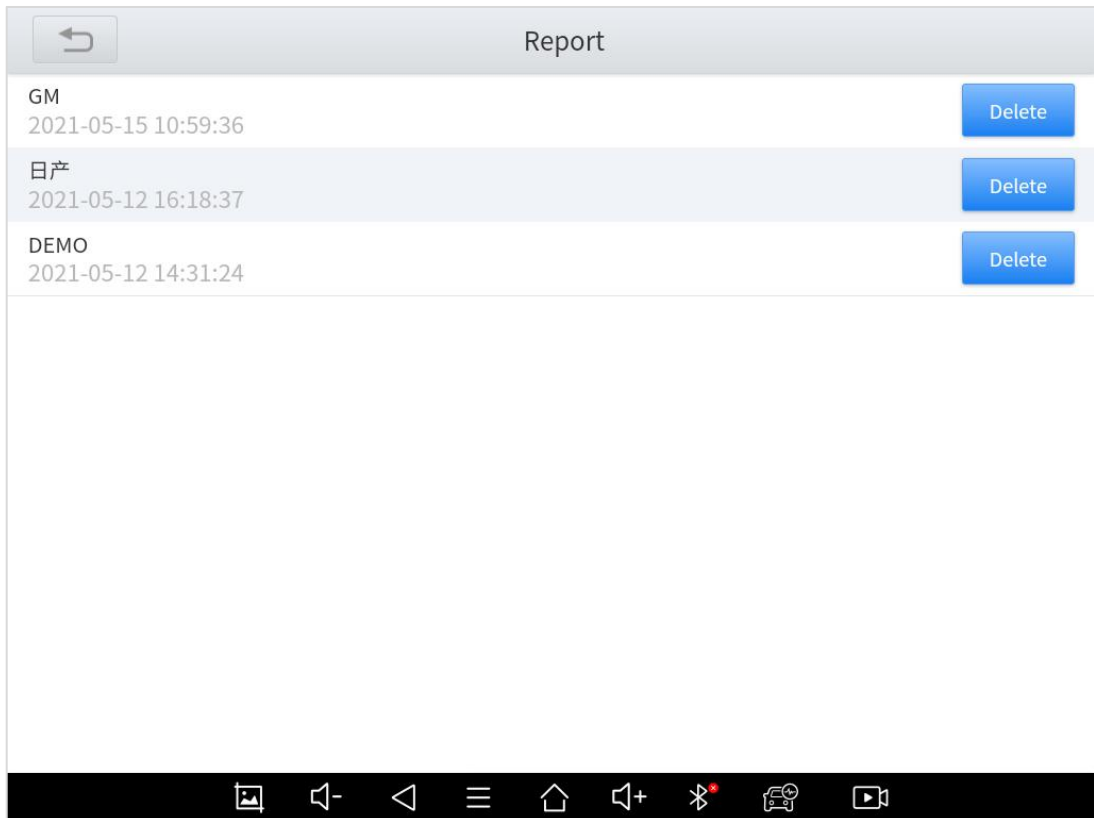

Fig 7-2

When you open the report, located in the header of the table is the studio information you filled in advance in the system setup, then the information of the vehicle, including the diagnosis date and time, VIN number, vehicle brand, diagnosis path, etc., as shown as below:



Fig 7-3

As you can see, you also could click "**Print PDF Report**" at the bottom right corner to output the paper version of the diagnostic results. If you need to close the report, you could tap on the button "**Exit**" that is on the left of "**Print PDF Report**"

8 REMOTE ASSISTANCE

Tap on "**Remote**" to start the TeamViewer quick support program, which is a simple, fast, and secure remote-control screen. You can use this application to enable them to control your tablet on a PC through the TeamViewer software, thereby obtaining temporary remote support from Xtool's technical support center.

Tablets and mobile devices running TeamViewer are identified by a globally unique ID. When the remote application is started for the first time, the ID will be automatically generated according to the hardware characteristics and will not be changed in the future. This TeamViewer ID can individually access all TeamViewer clients.

Before launching the remote desktop application, make sure that the tablet is connected to the Internet so that you can access the tablet to receive remote support from a third party. If you encounter problems and are not able to solve them, you could open this application and ask for remote assistance.

To obtain remote support from your partners or Xtool After-service Center:

1. Turn on the power of the tablet.
2. Click **Remote** in the diagnosis application. The TeamViewer screen is displayed, and the device ID will be generated.

3. Your partner must install the remote-control software on his/her tablet by downloading the full version of TeamViewer program (<http://www.teamviewer.com>) online, and then start the software on his/her tablet at the same time, in order to provide support and remote control of the tablet.
4. Provide your ID to the partner or Xtool technician, and then wait for him/her to send you a remote-control request.
5. A pop-up window will be shown for asking you to confirm to allow the remote-control program to control your device.
6. Click **Allow** to accept, or click **Reject** to reject.

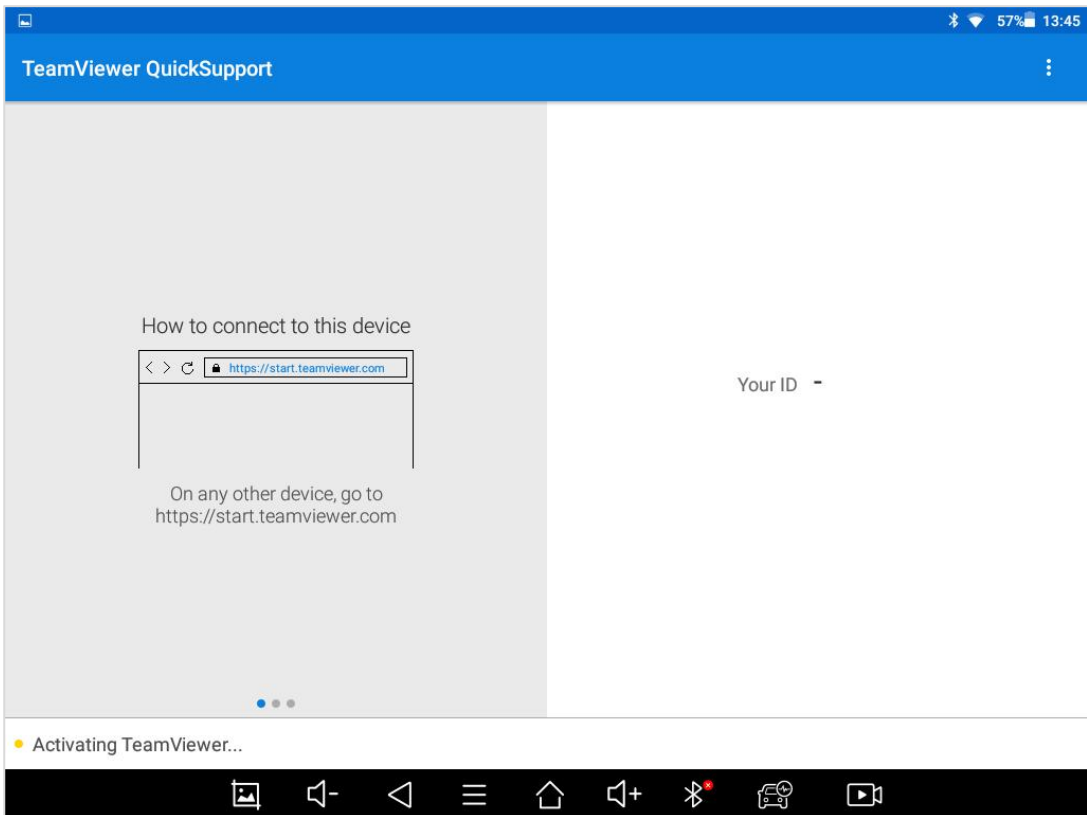

Fig 8-1

SHENZHEN XTOOLTECH INTELLIGENT CO., LTD

Company address: 17&18/F, Building A2, Creativity City, Liuxian Avenue, Nanshan District, Shenzhen, China

Factory address: 2/F, Building 12, Tangtou Third Industrial Zone, Shiyan Street, Baoan District, Shenzhen, China

Service Hotline: 0086-755-21670995/86267858

Email: marketing@Xtooltech.com

Fax: 0755-83461644

Website: www.Xtooltech.com

Dealer:www.xtool.co.uk